

FOLD LINE TO TOP PANEL - DO NOT CUT

PANEL 1 EXTERIOR LEFT SIDE

SLOT G

SLOT E

SLOT C

SLOT A

CENTERLINE OF BOX

WIDTH OF BOX = 2'-7" (31")

IF USING A WIDER BOX - TAKE WIDTH OF YOUR BOX MINUS 31" = AMOUNT LARGER. TAKE THE AMOUNT LARGER AND DIVIDE BY 2. THIS IS DIMENSION X" AND SHOULD BE ADDED AT ALL LOCATIONS WHERE INDICATED.
PAINT LINE

← ADD X" HERE
IF USING
WIDER BOX

→ ADD X" HERE
IF USING
WIDER BOX

AA SLOTS FOR
PIECE 16 -
INTERIOR LEFT
SIDE

CUT OR PAINT LINES FOR WINDOWS

PAINT LINES FOR PANELS

SHADED AREAS
(DARKER)

HIGHLIGHTED
AREAS (LIGHTER)

PAINT LINE

PAINT LINE

CUT LINE

FOLD LINE TO TOP PANEL - DO NOT CUT

CENTERLINE OF BOX

PANEL 2 EXTERIOR FRONT

SLOT I

SLOT J

← ADD X" HERE
IF USING
WIDER BOX

→ ADD X" HERE
IF USING
WIDER BOX

CUT LINE

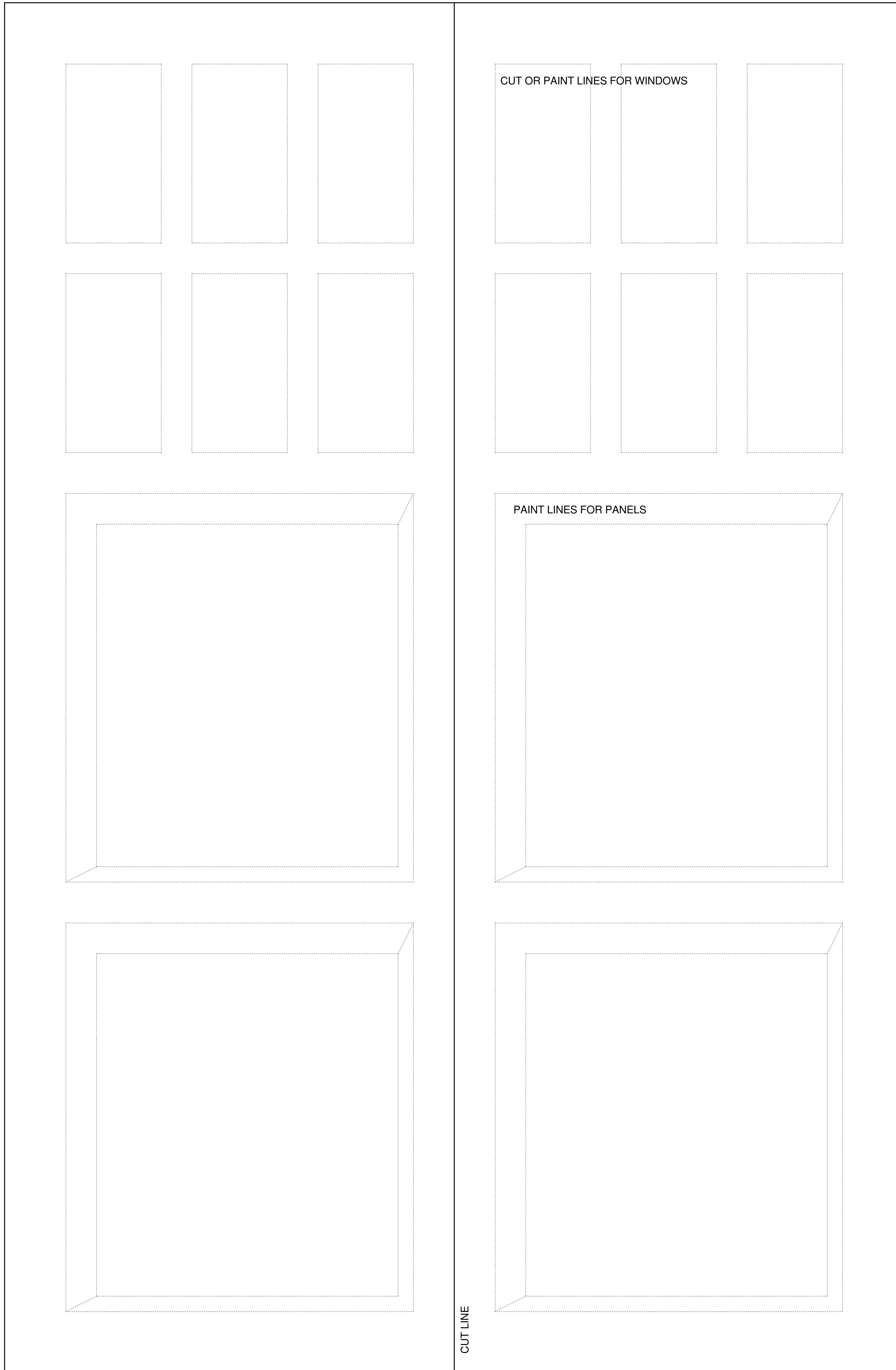

CUT OR PAINT LINES FOR WINDOWS

PAINT LINES FOR PANELS

CUT LINE

CUT LINE

CUT LINE

FOLD LINE TO TOP PANEL - DO NOT CUT



SLOT B

← ADD X" HERE IF USING WIDER BOX

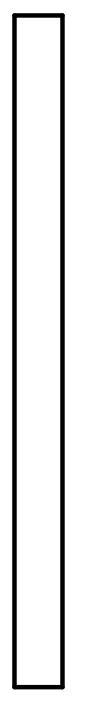

SLOT D

CENTERLINE OF BOX

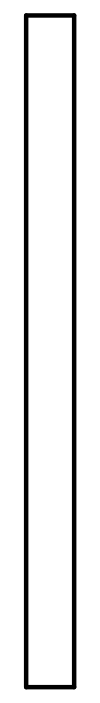

SLOT F

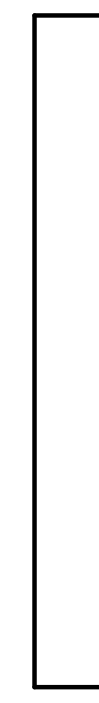

SLOT H

← ADD X" HERE IF USING WIDER BOX

PANEL 3 EXTERIOR RIGHT SIDE

PAINT LINE

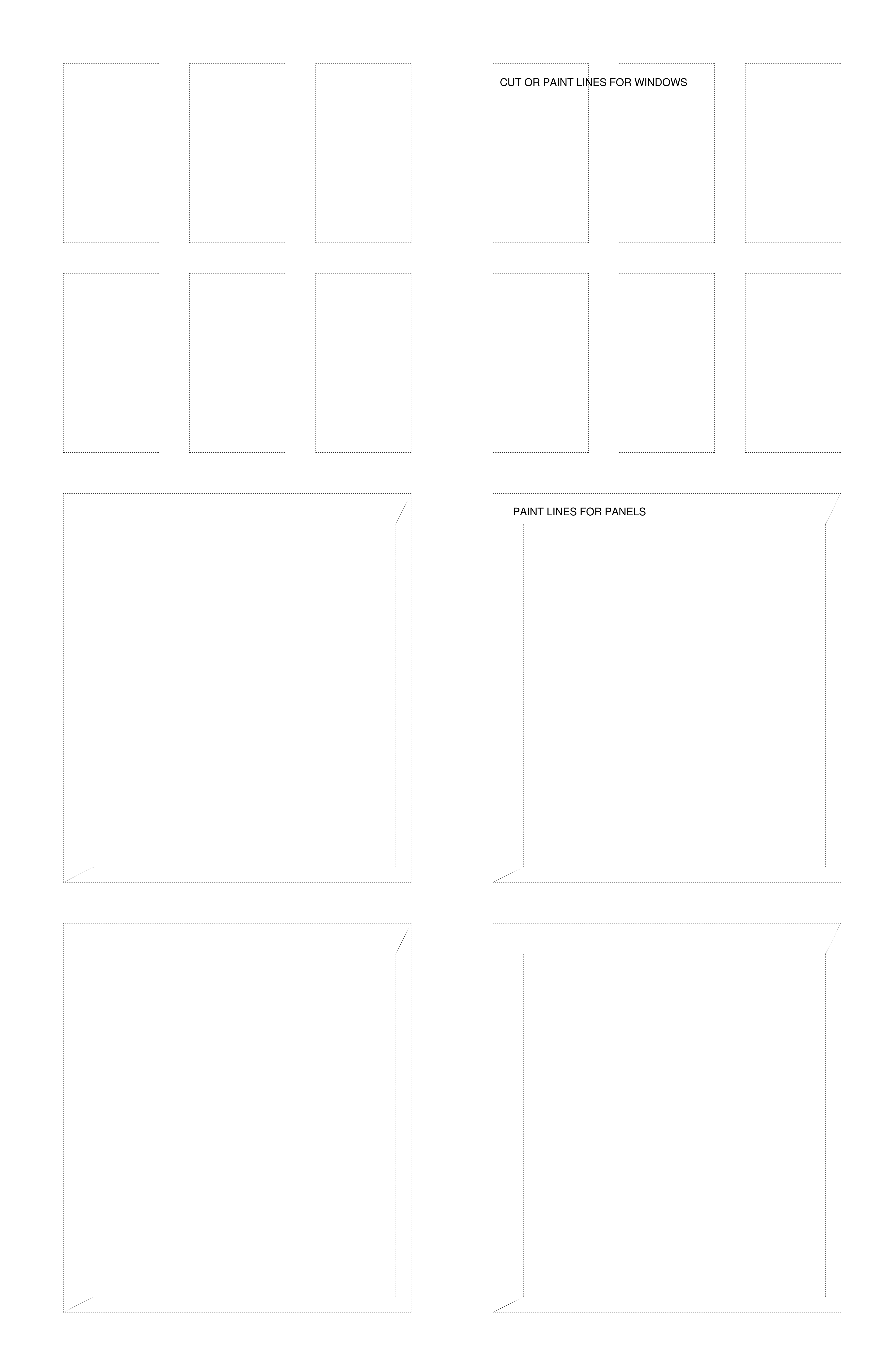

BB SLOTS FOR
PIECE 18 -
INTERIOR
RIGHT SIDE

CUT OR PAINT LINES FOR WINDOWS

PAINT LINES FOR PANELS

PAINT LINE

CUT LINE

AA TABS FOR
PIECE 1 -
EXTERIOR
LEFT SIDE

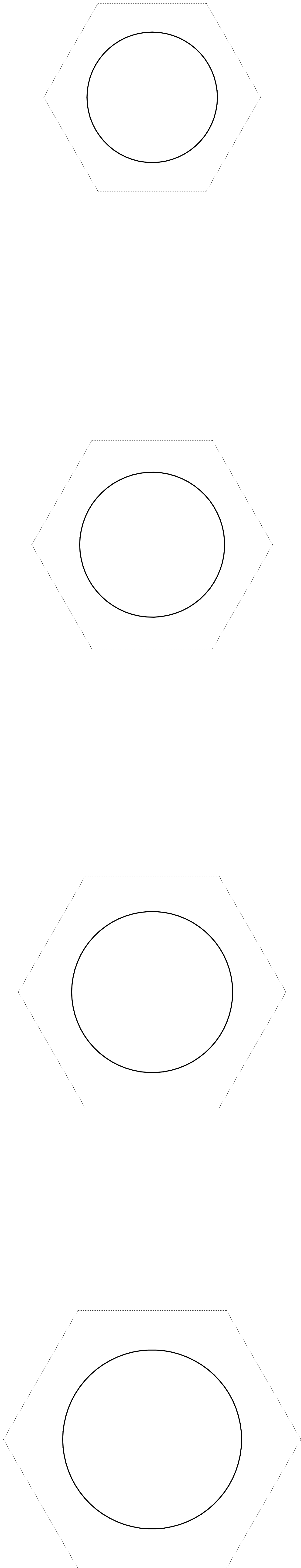

CENTERLINE OF BOX - FOLD INWARD

PANEL16 INTERIOR LEFT SIDE

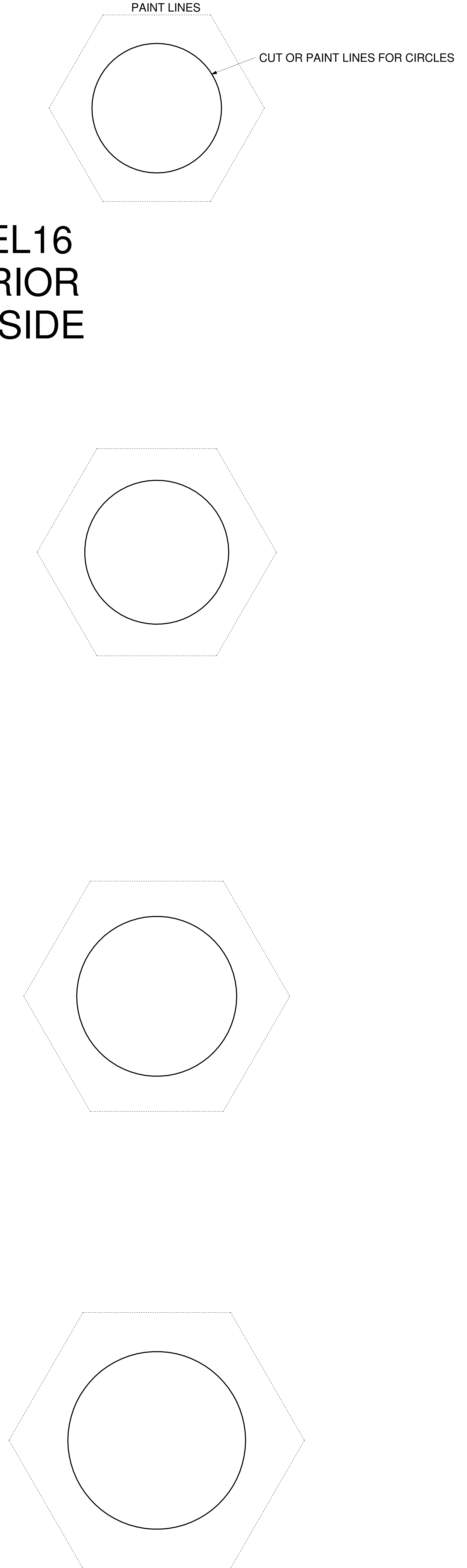

CUT LINE - TOP OF BOX

PAINT LINES

CUT OR PAINT LINES FOR CIRCLES

CUT LINE - BOTTOM OF BOX

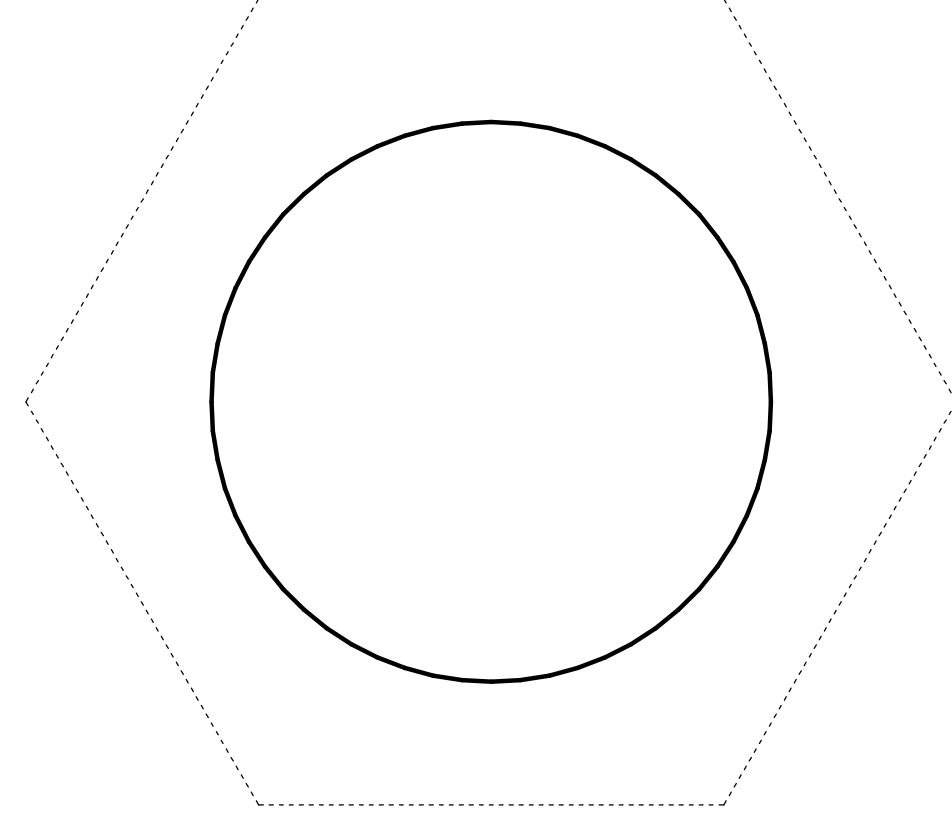
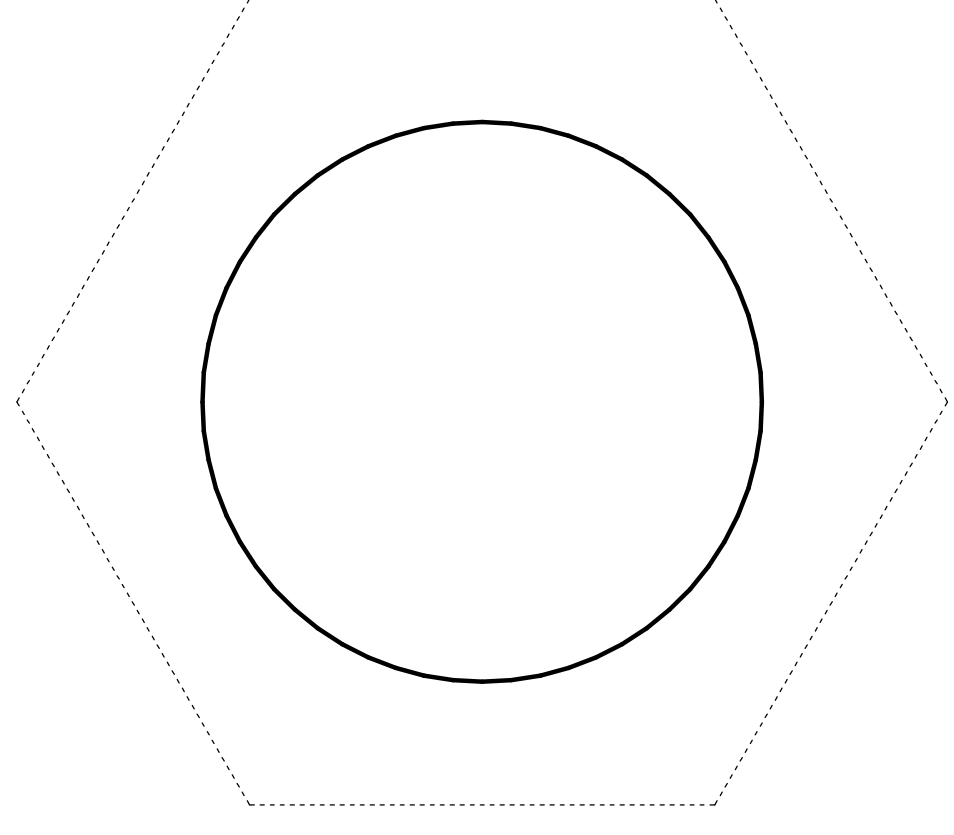

PANEL 17
INTERIOR
BACK

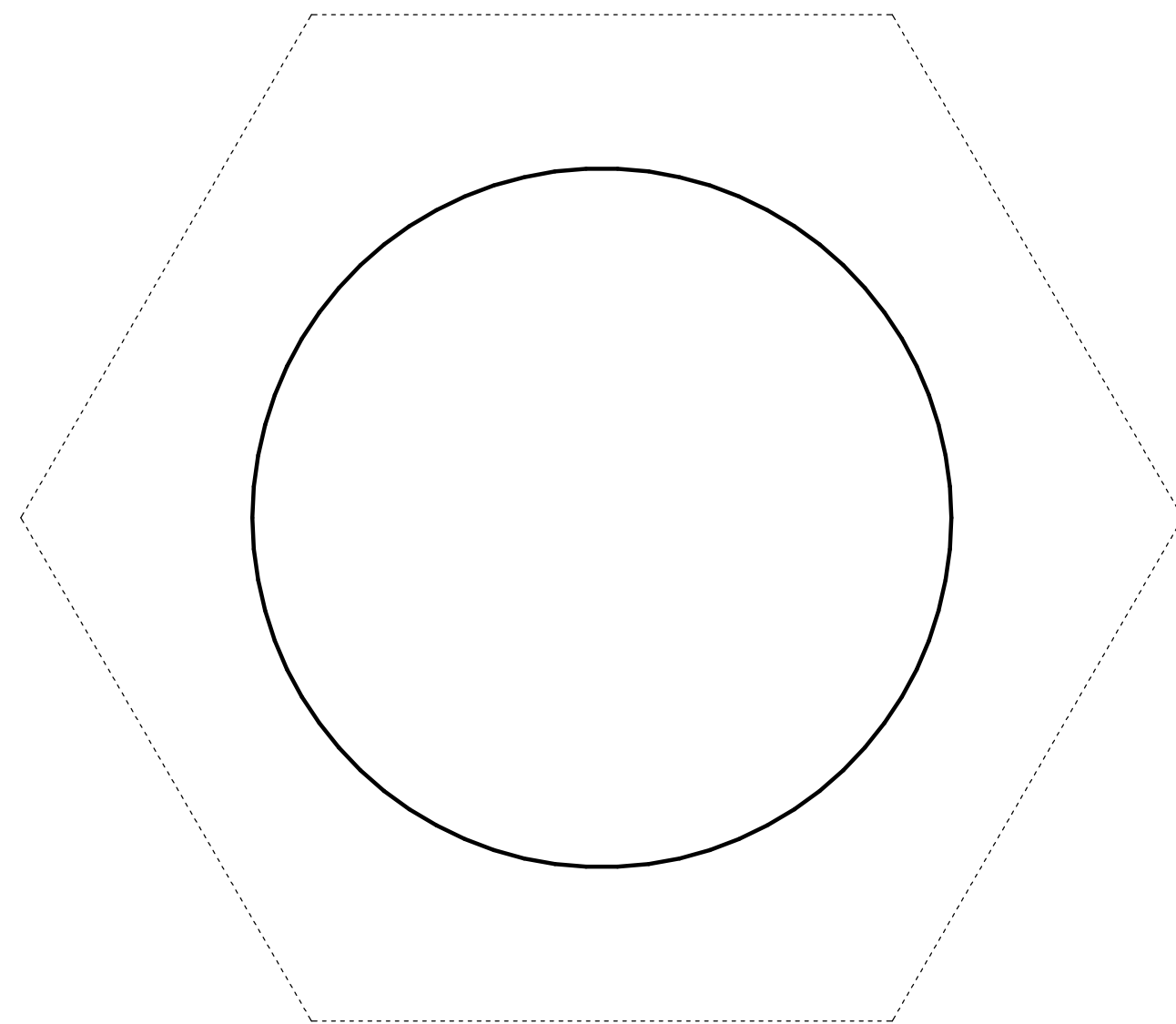
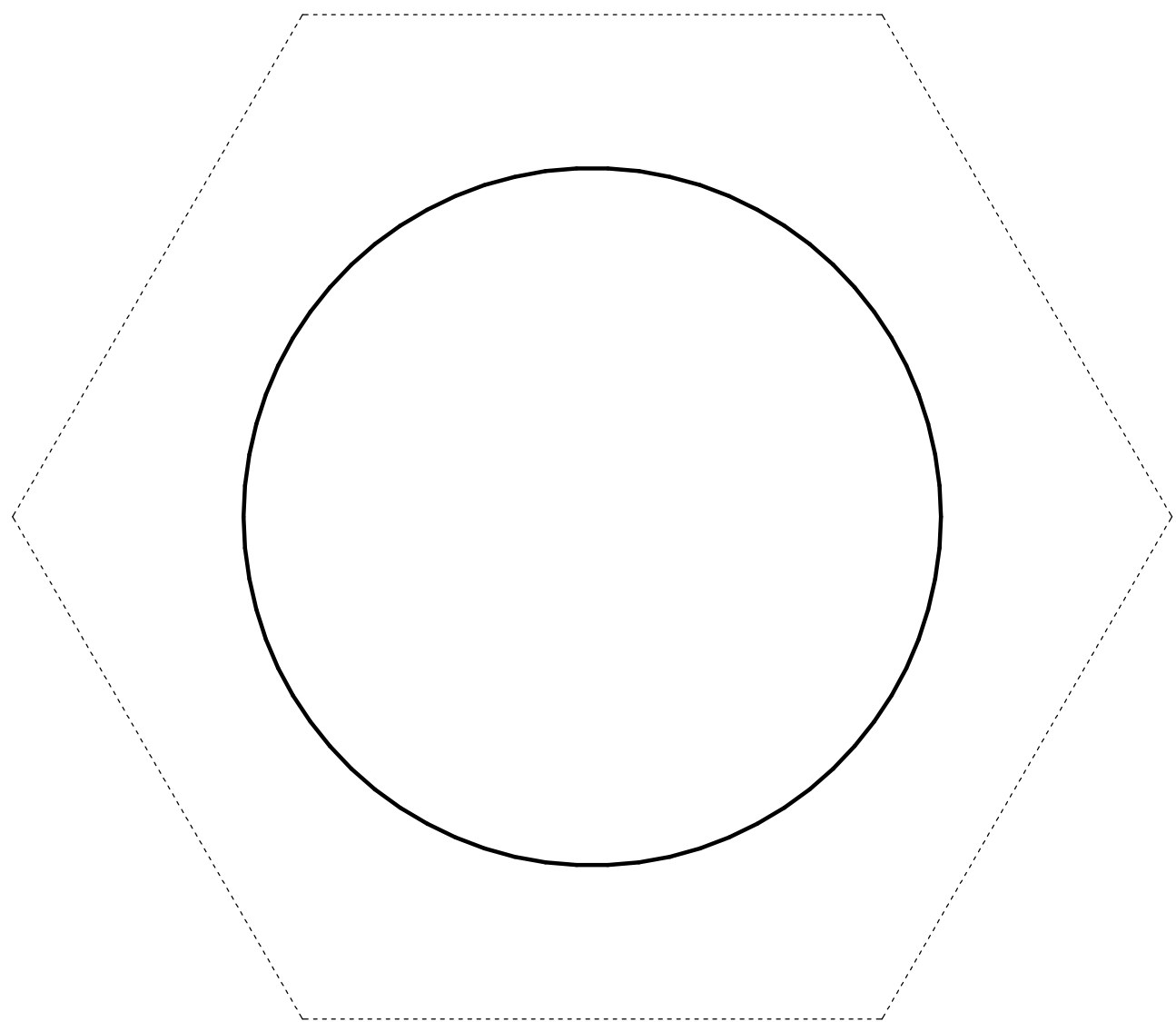
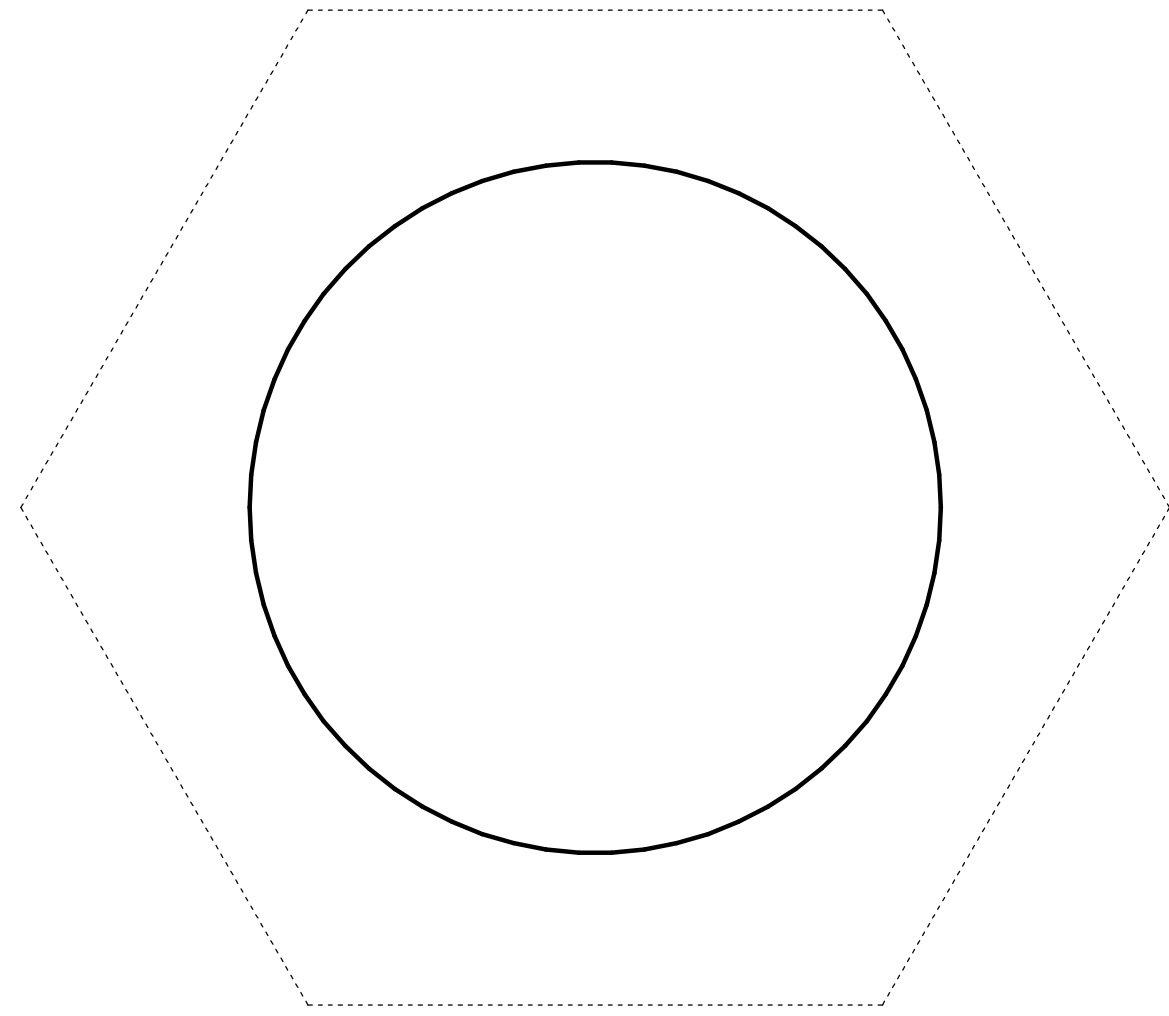
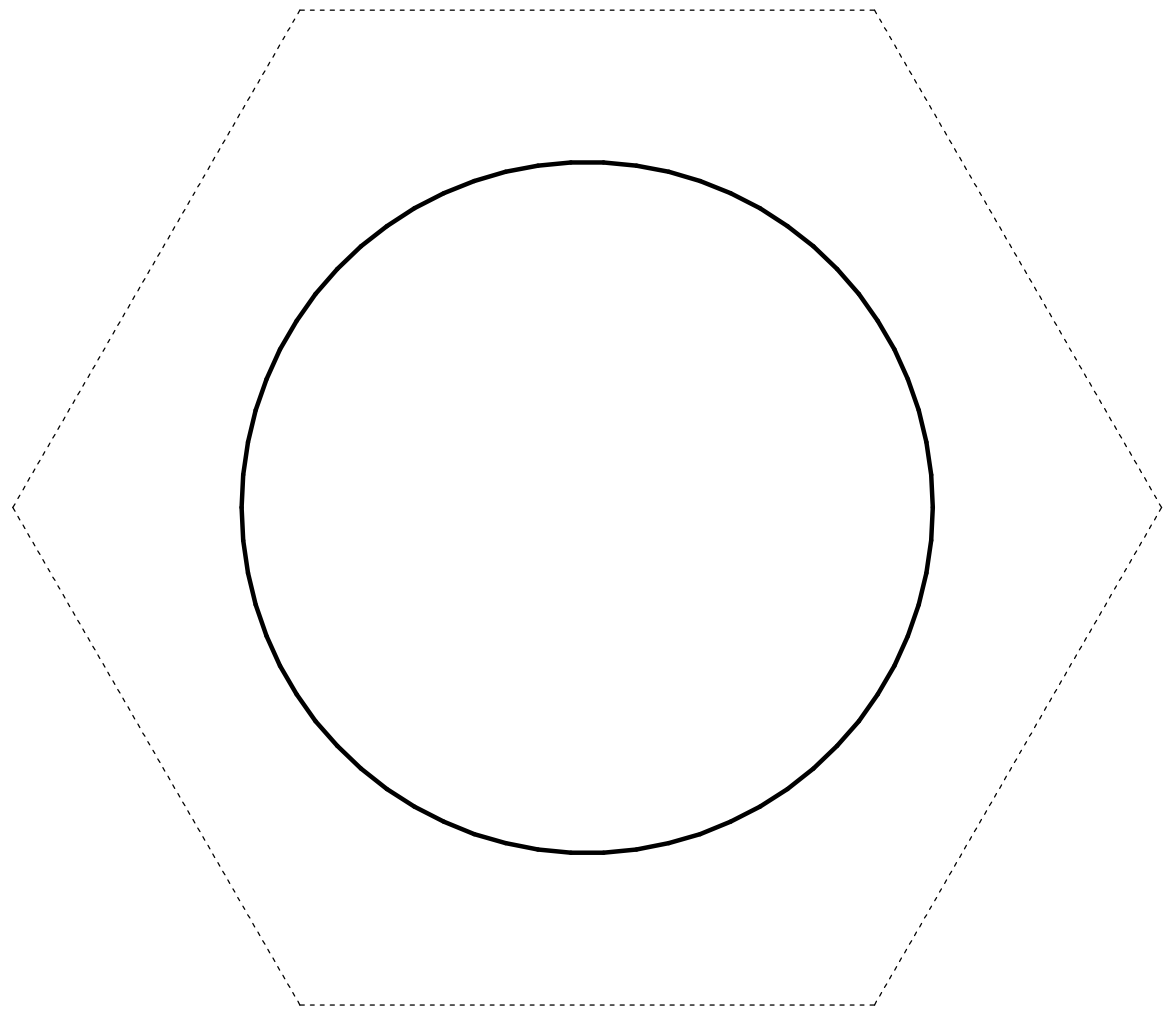
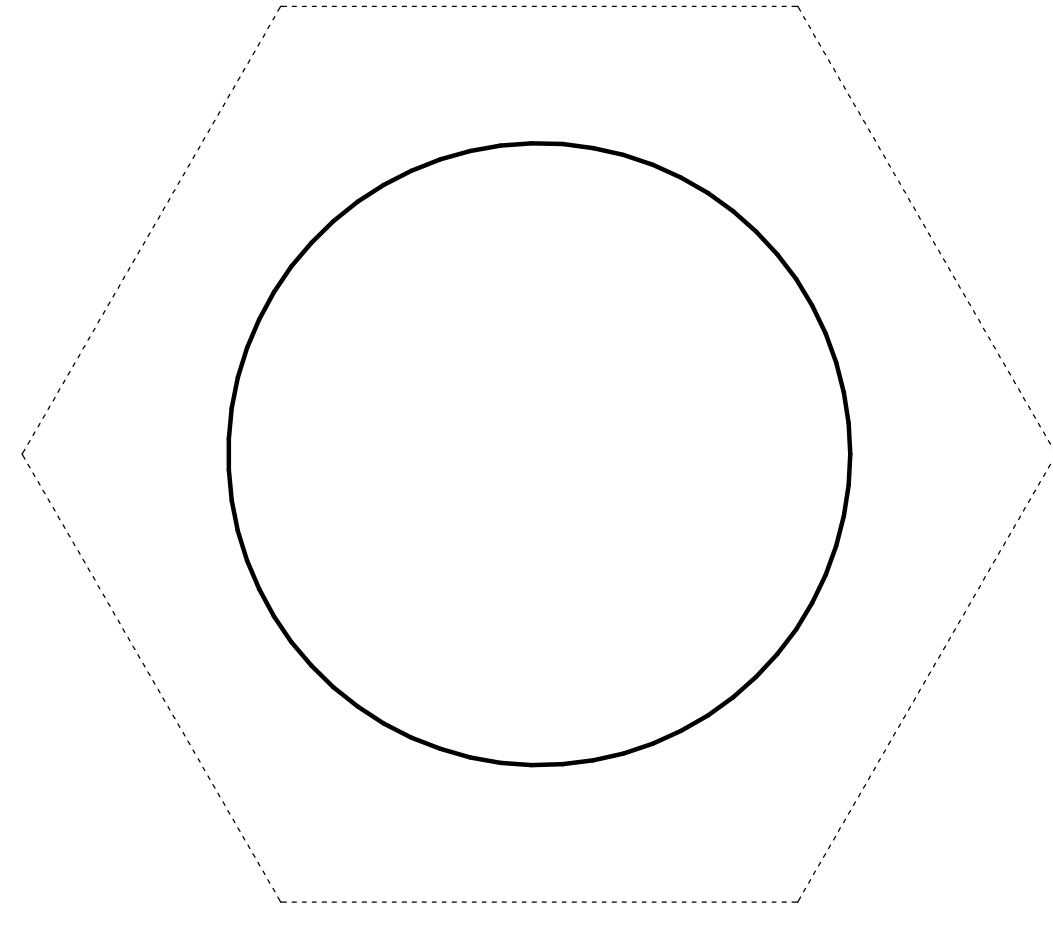
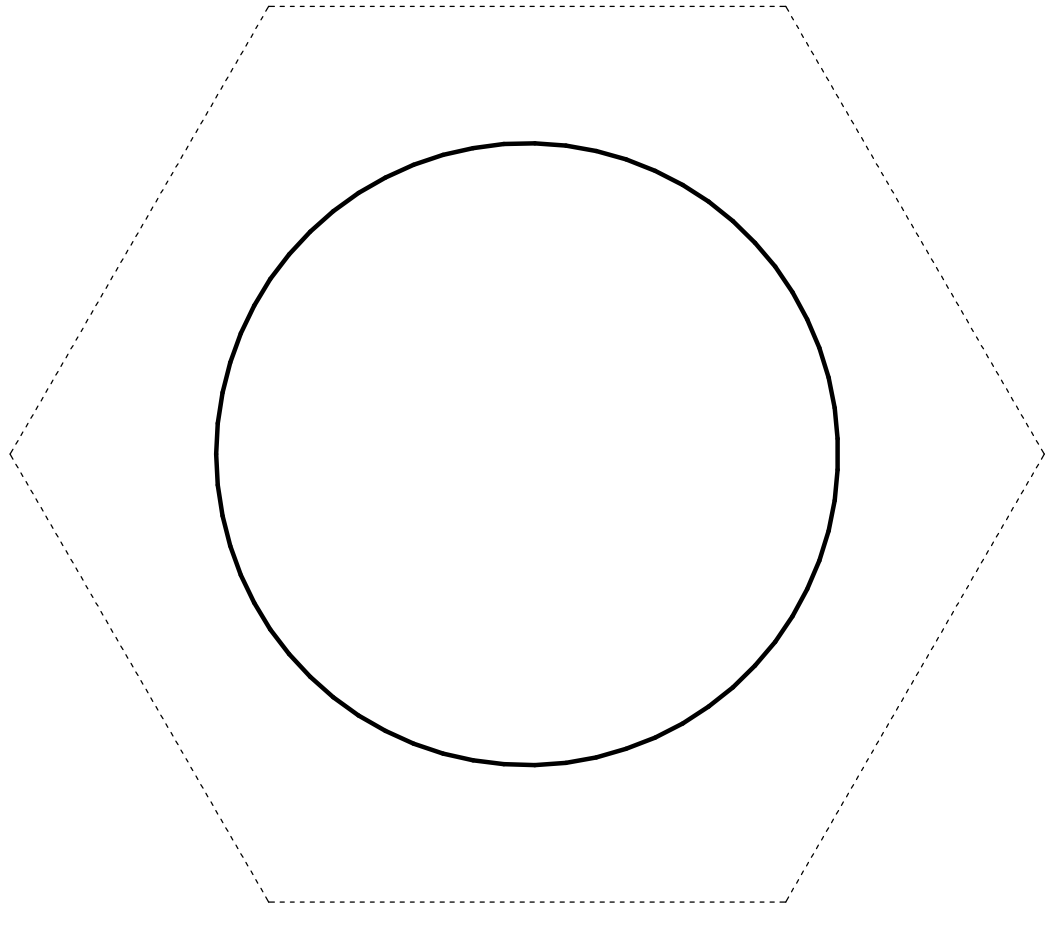

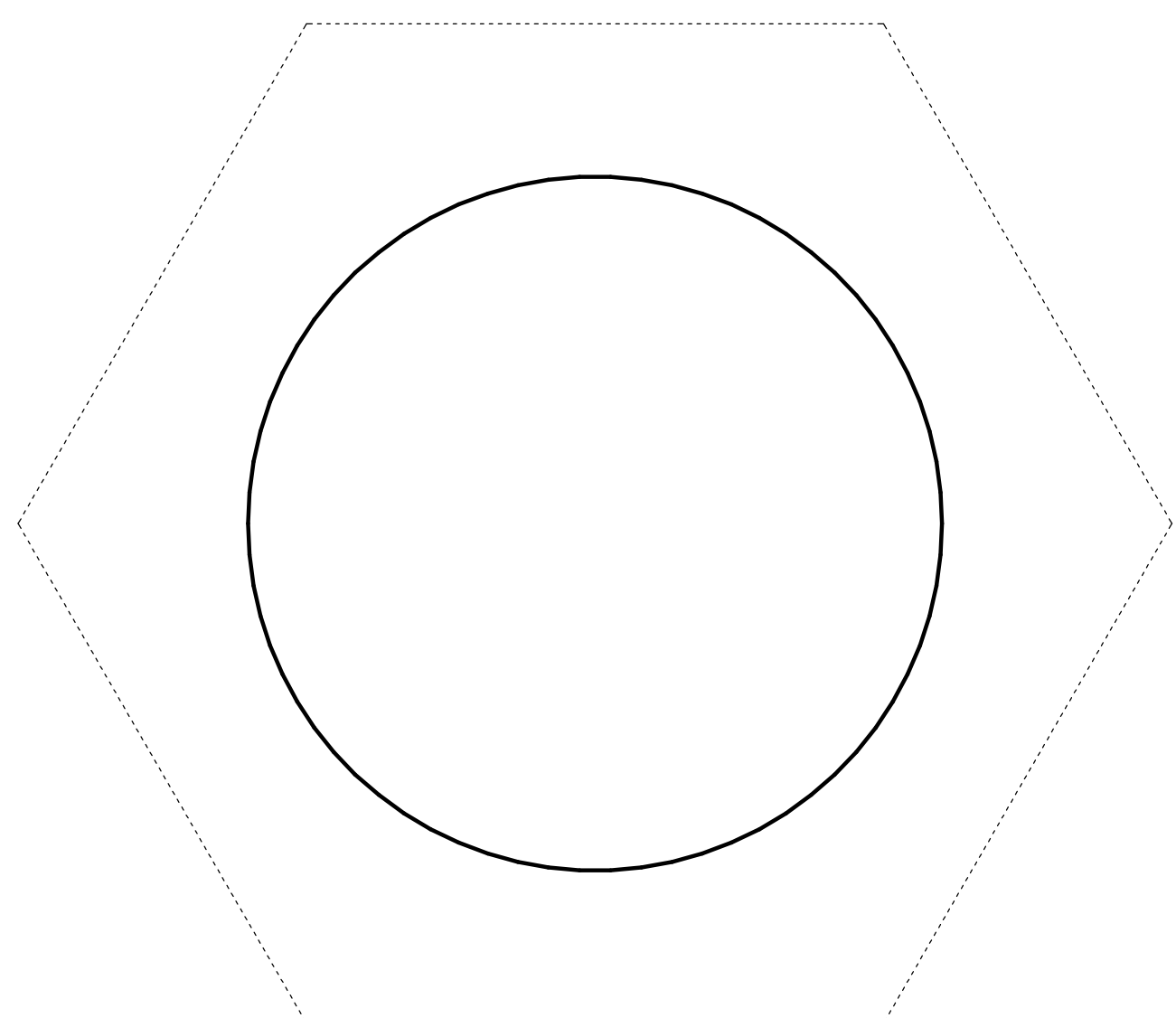
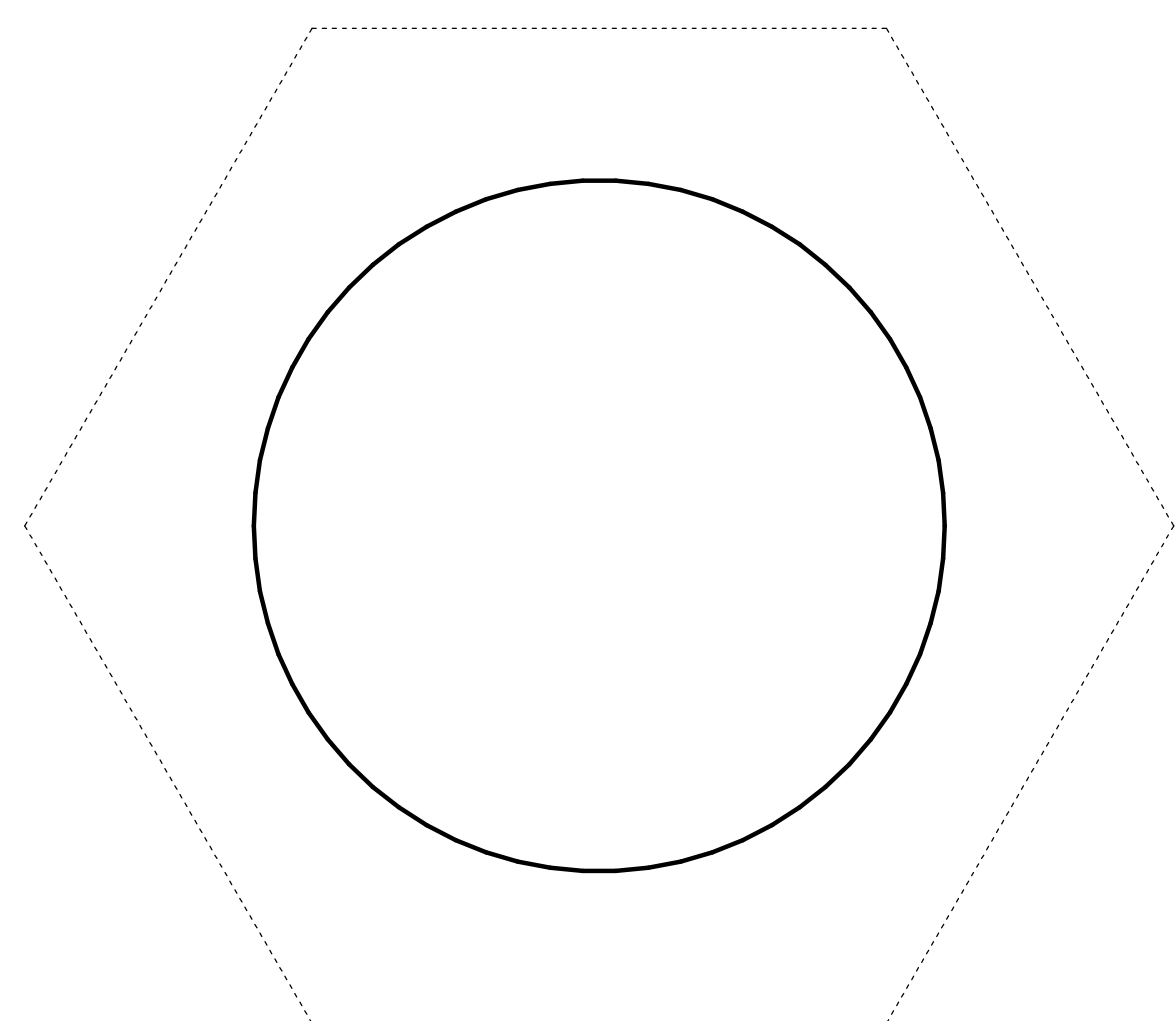
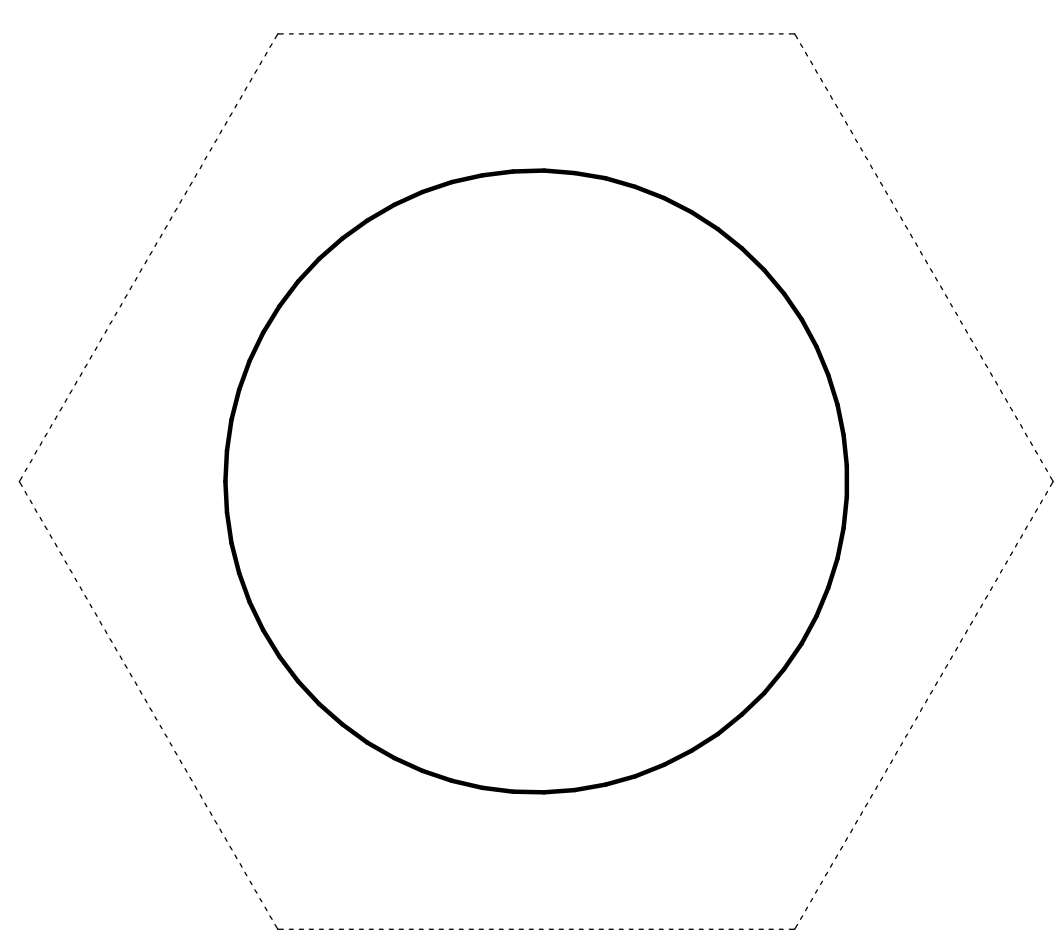
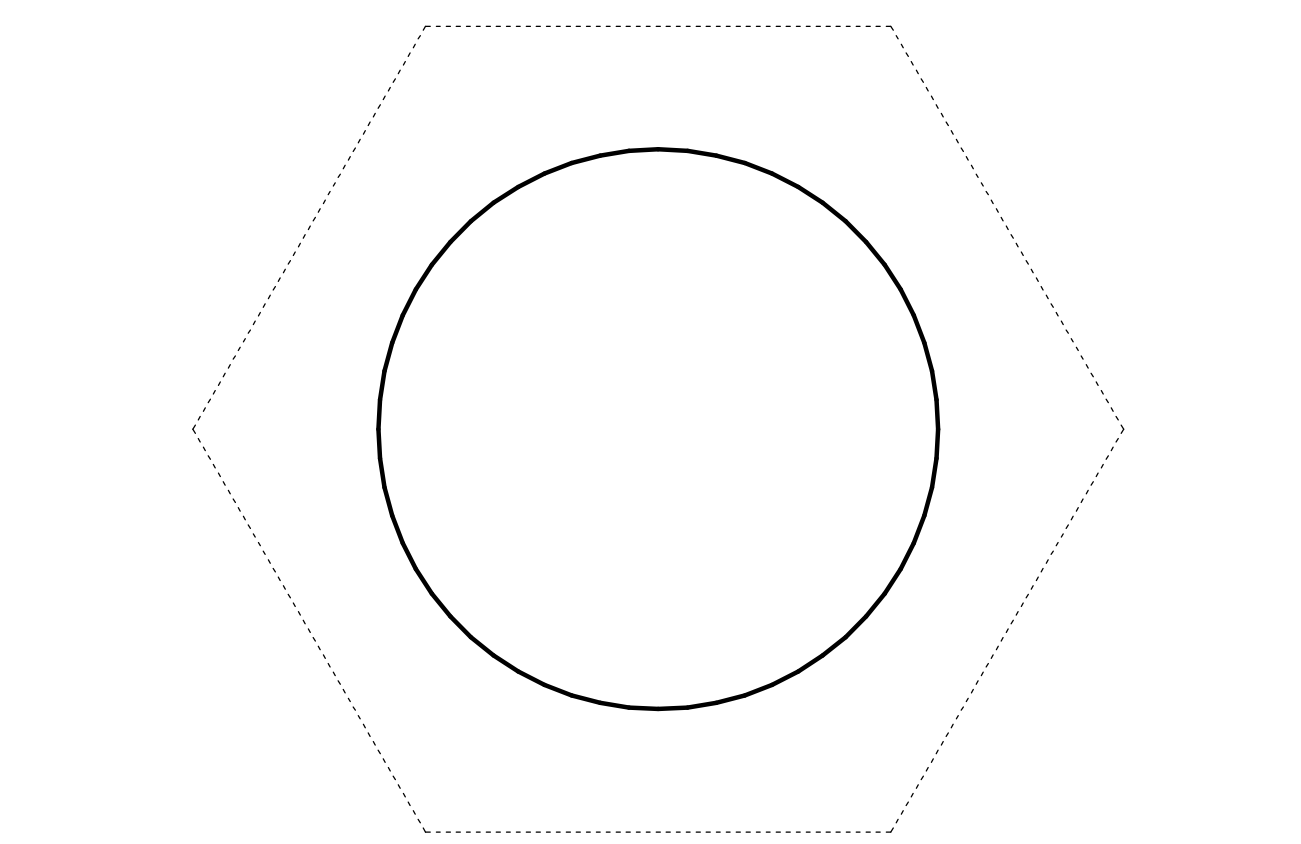

CENTERLINE OF BOX - FOLD INWARD

CUT LINE - TOP OF BOX

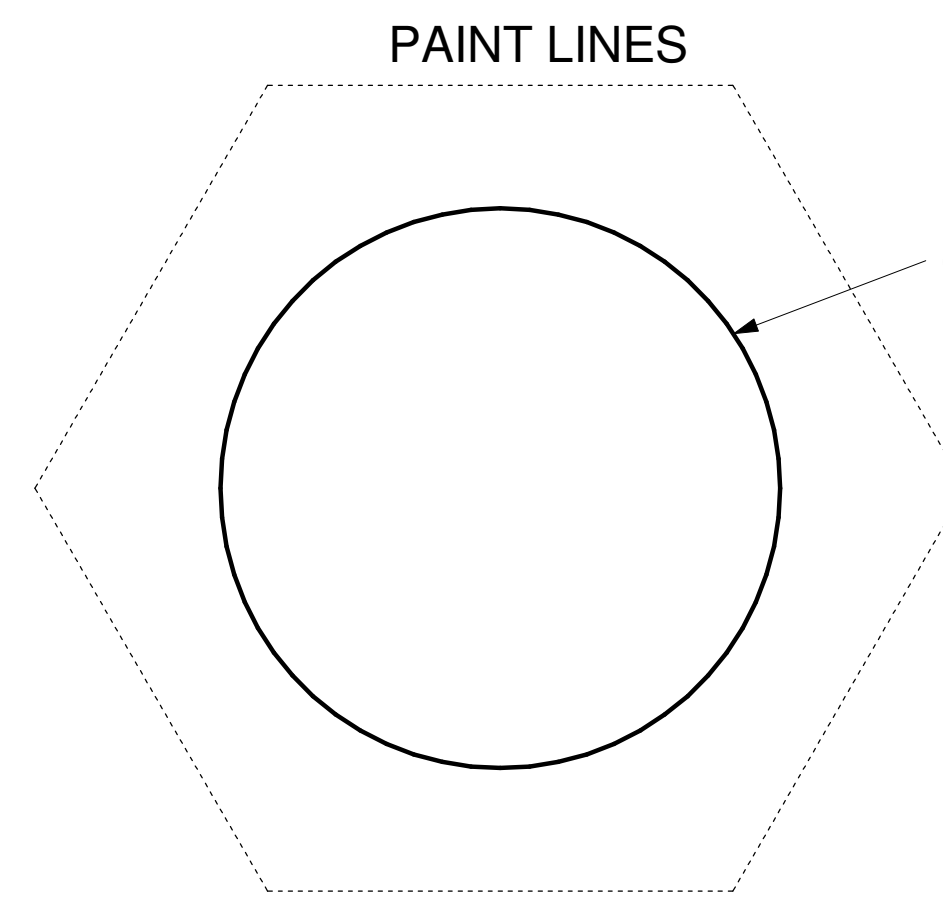

PANEL 18 INTERIOR RIGHT SIDE

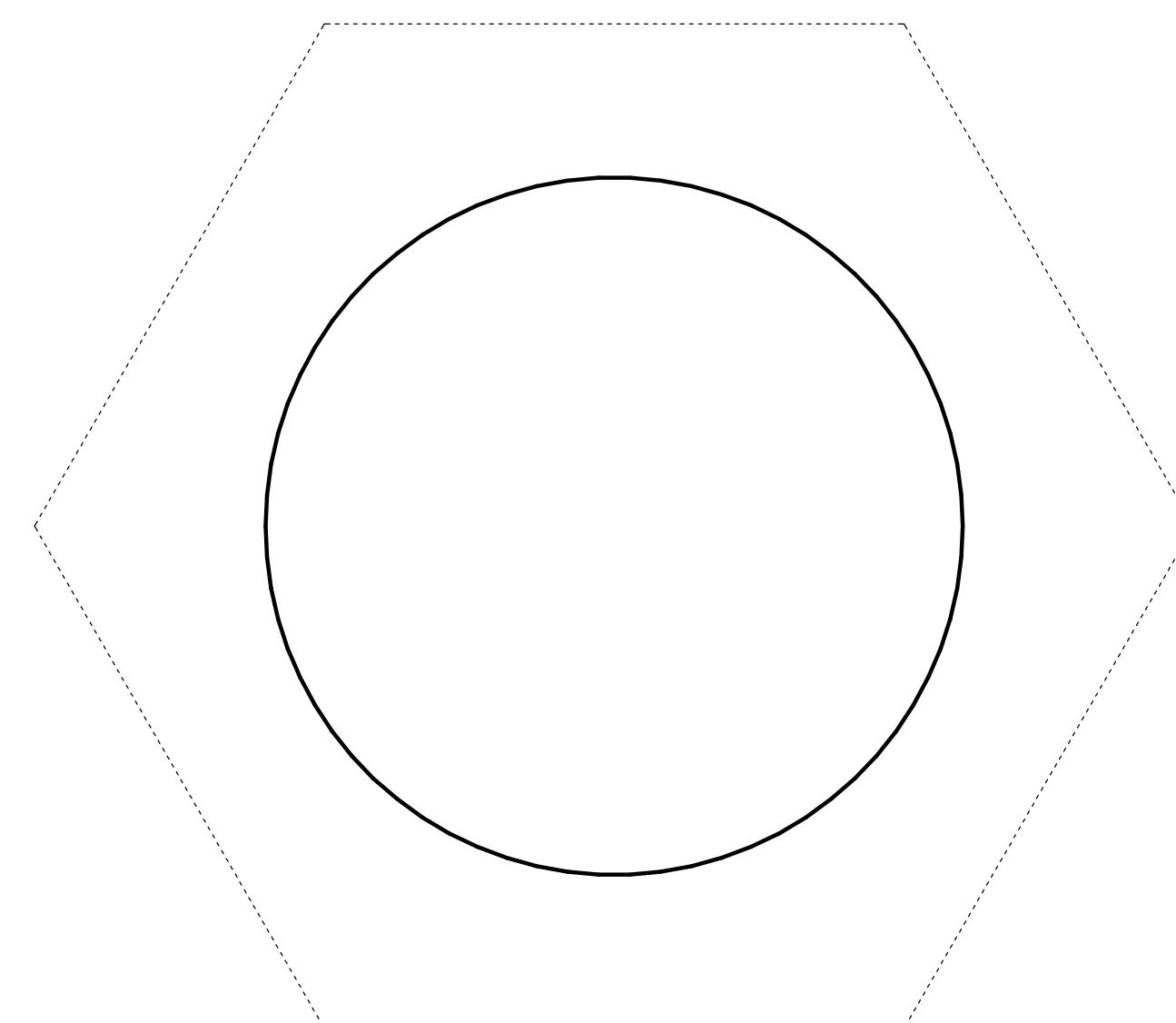
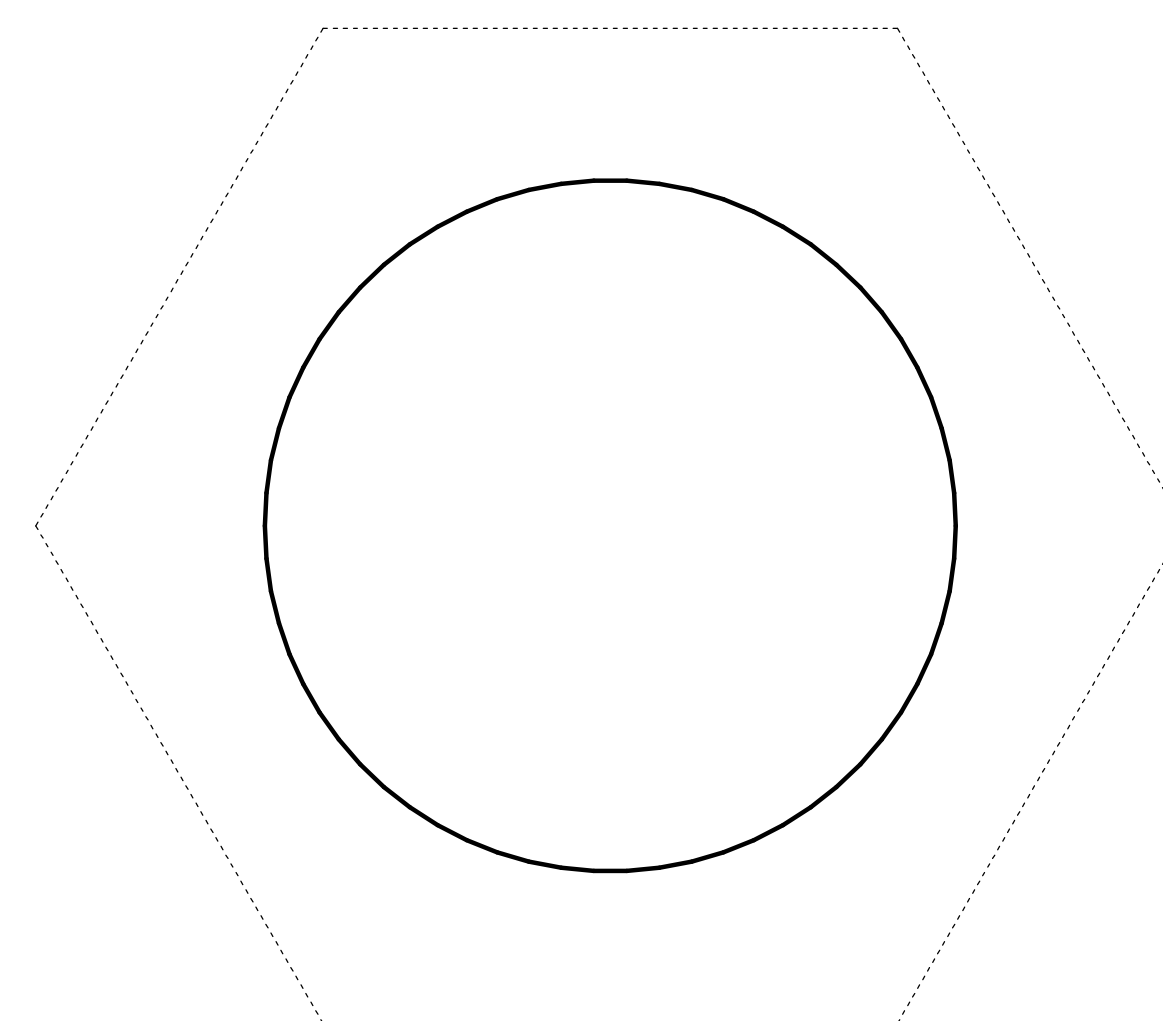
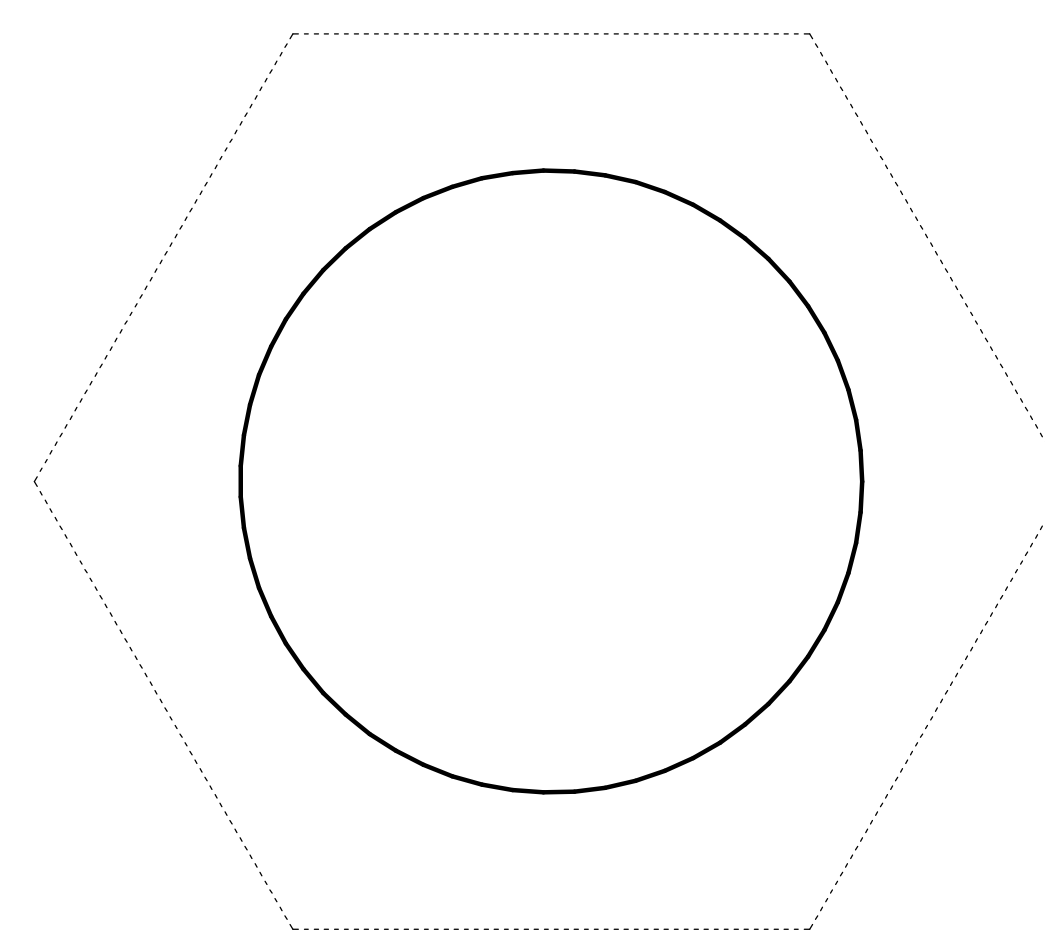

BB TABS FOR
PIECE 3 -
EXTERIOR
RIGHT SIDE

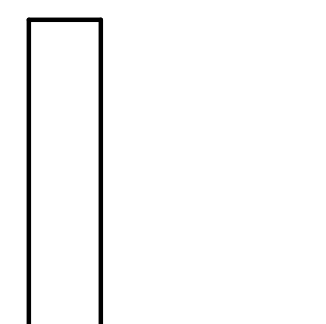
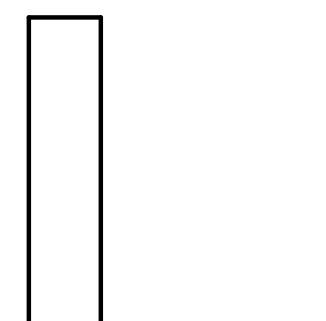
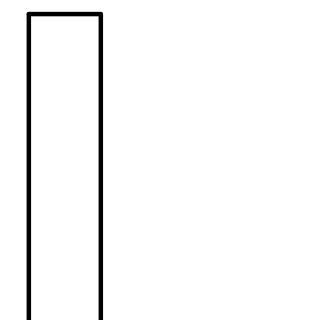
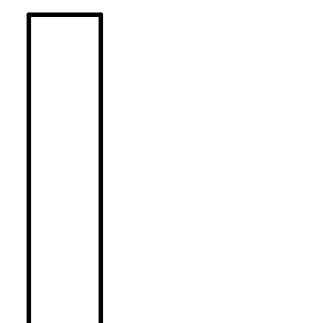

CUT LINE - BOTTOM OF BOX

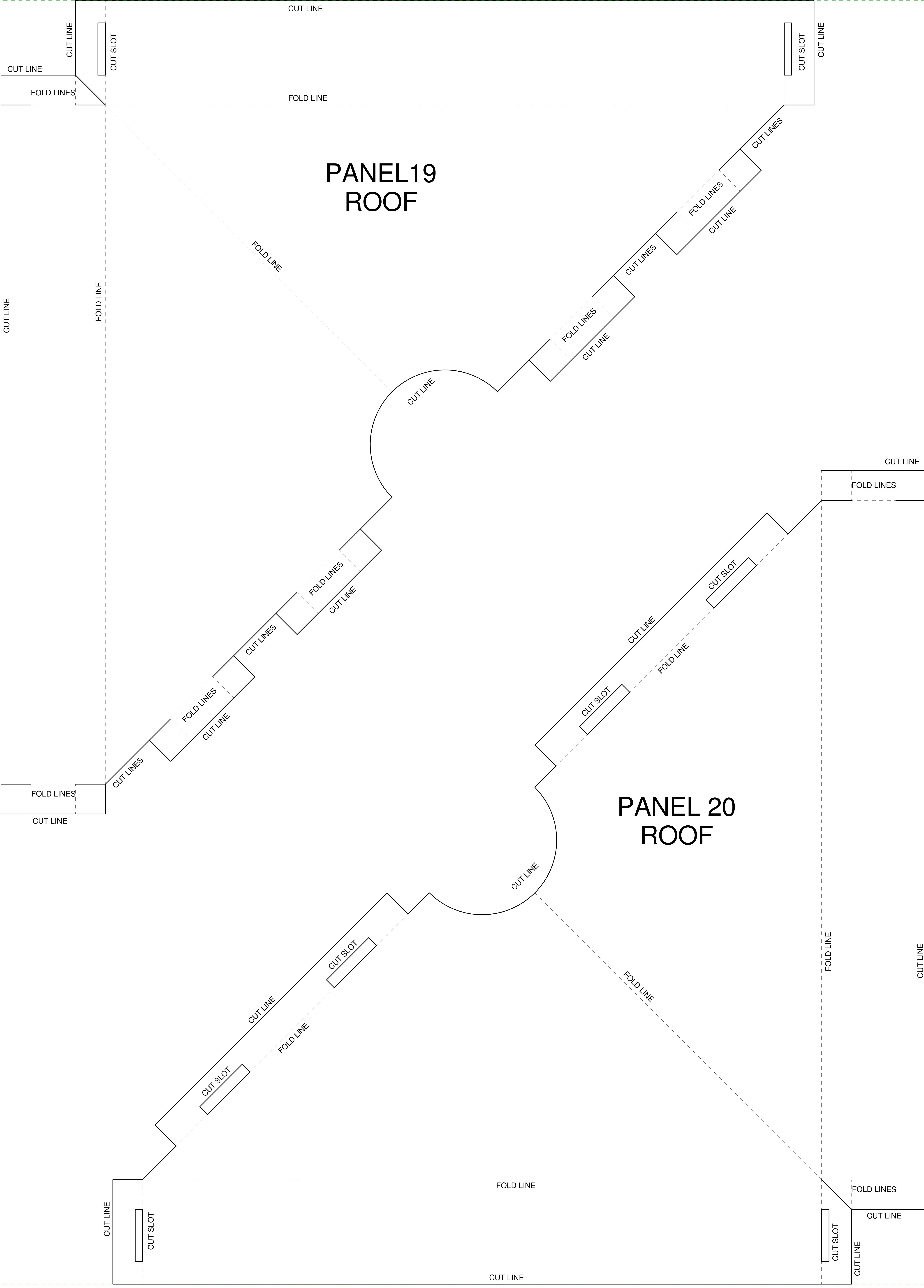

PANEL 19
ROOF

PANEL 20
ROOF

PANEL 27
INNER ROOF
SUPPORTS -
PERPENDICULAR
TO FRONT

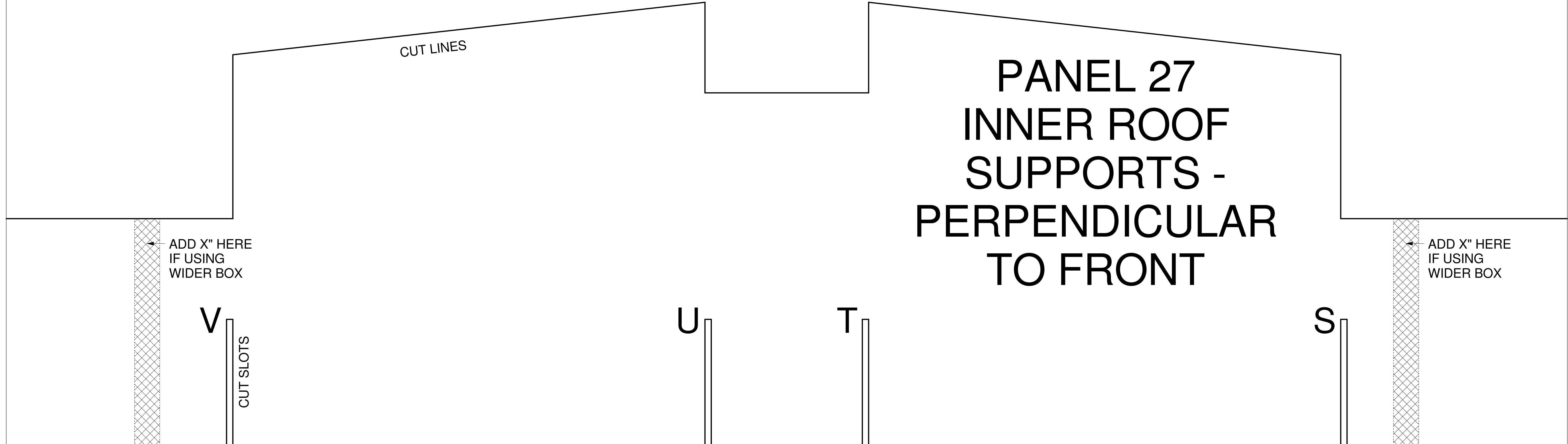

PANEL 22
INNER ROOF
SUPPORTS -
PARALLEL TO
FRONT

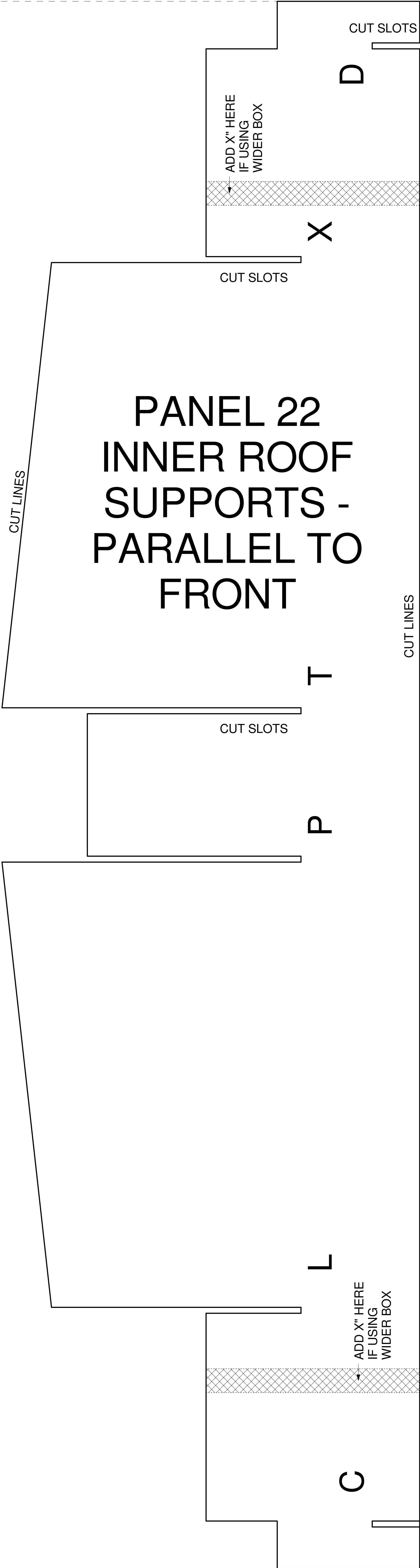

PANEL 24
OUTER ROOF
SUPPORTS -
PARALLEL TO
FRONT

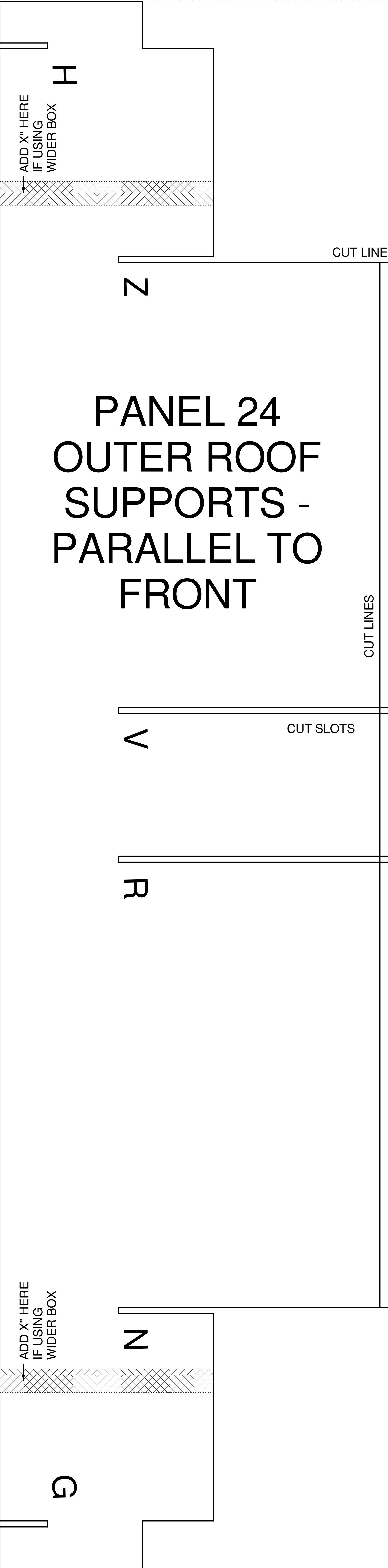

PANEL 21
OUTER ROOF
SUPPORTS -
PARALLEL TO
FRONT

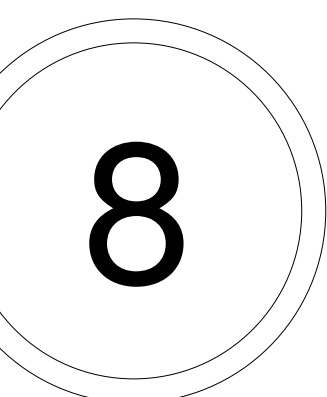
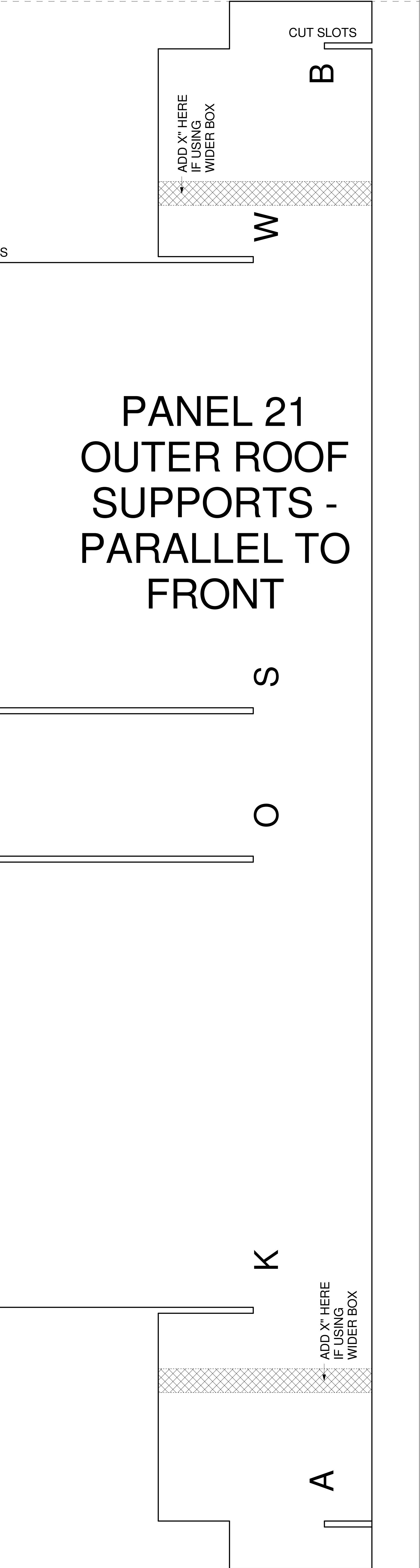

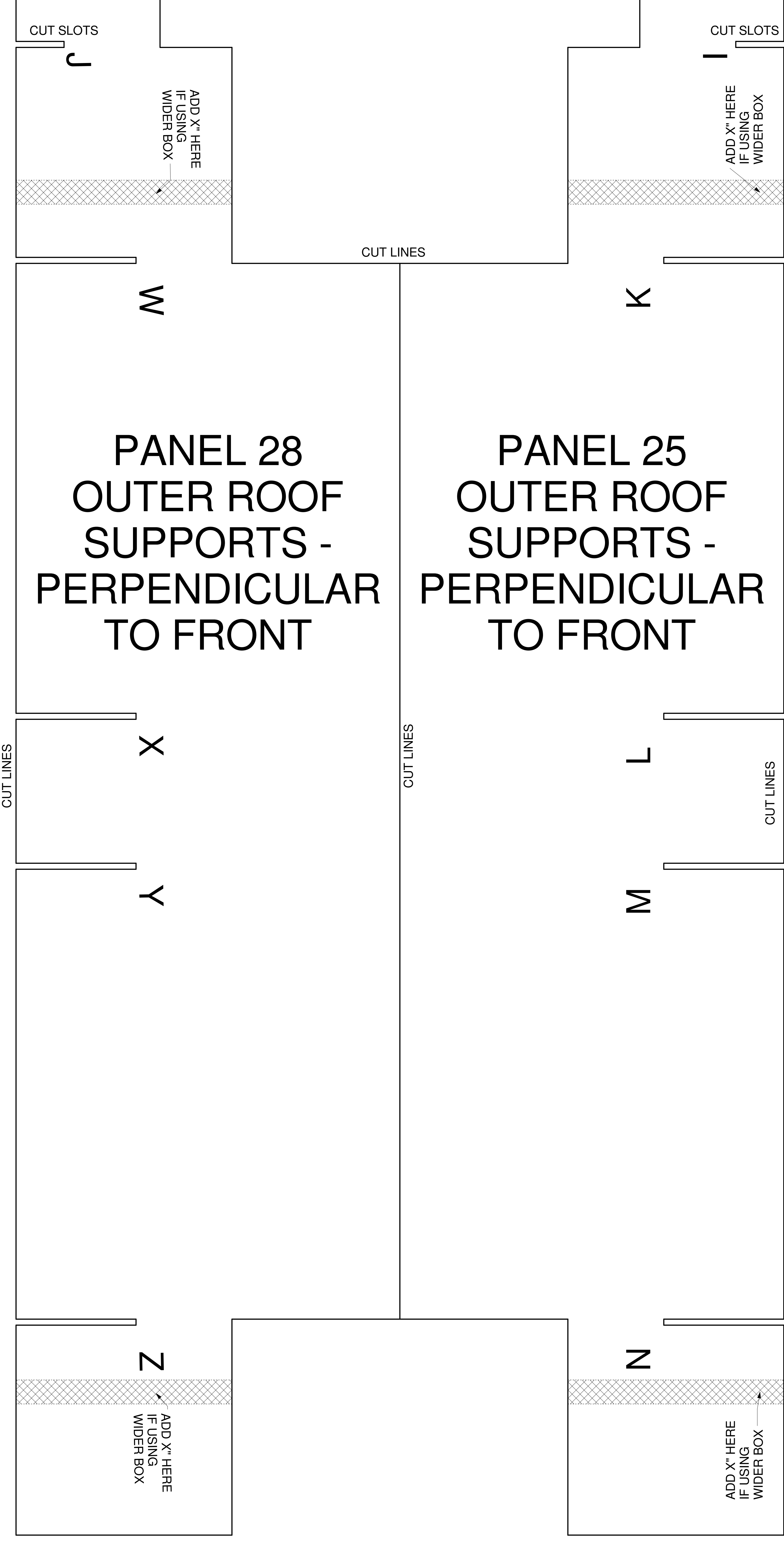
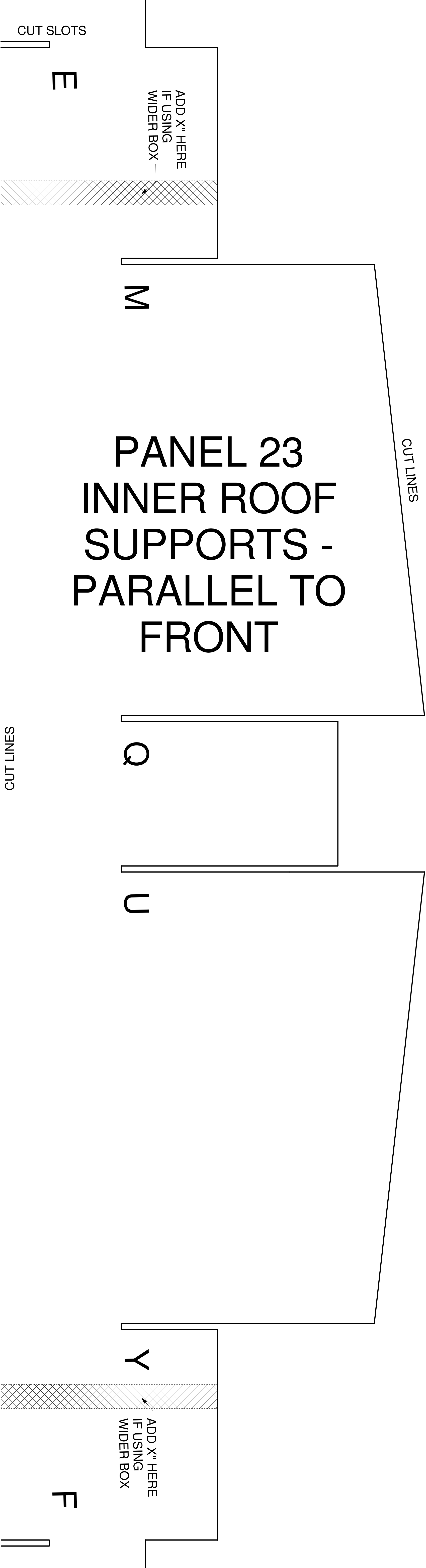
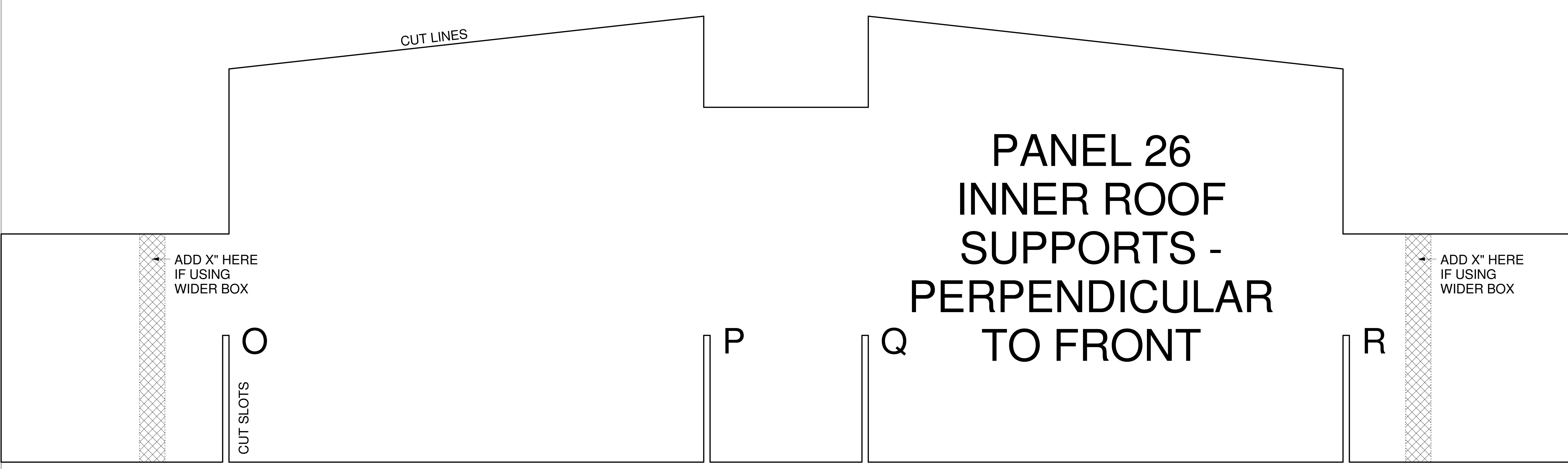

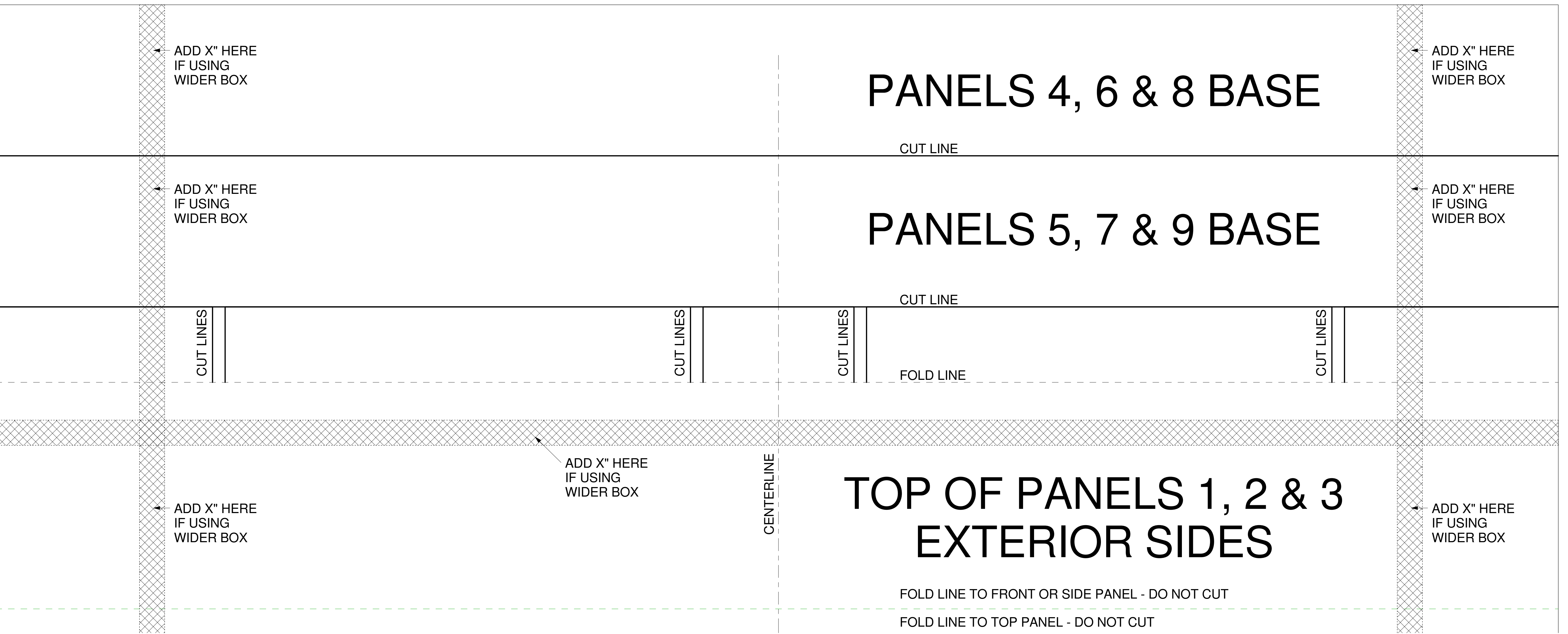

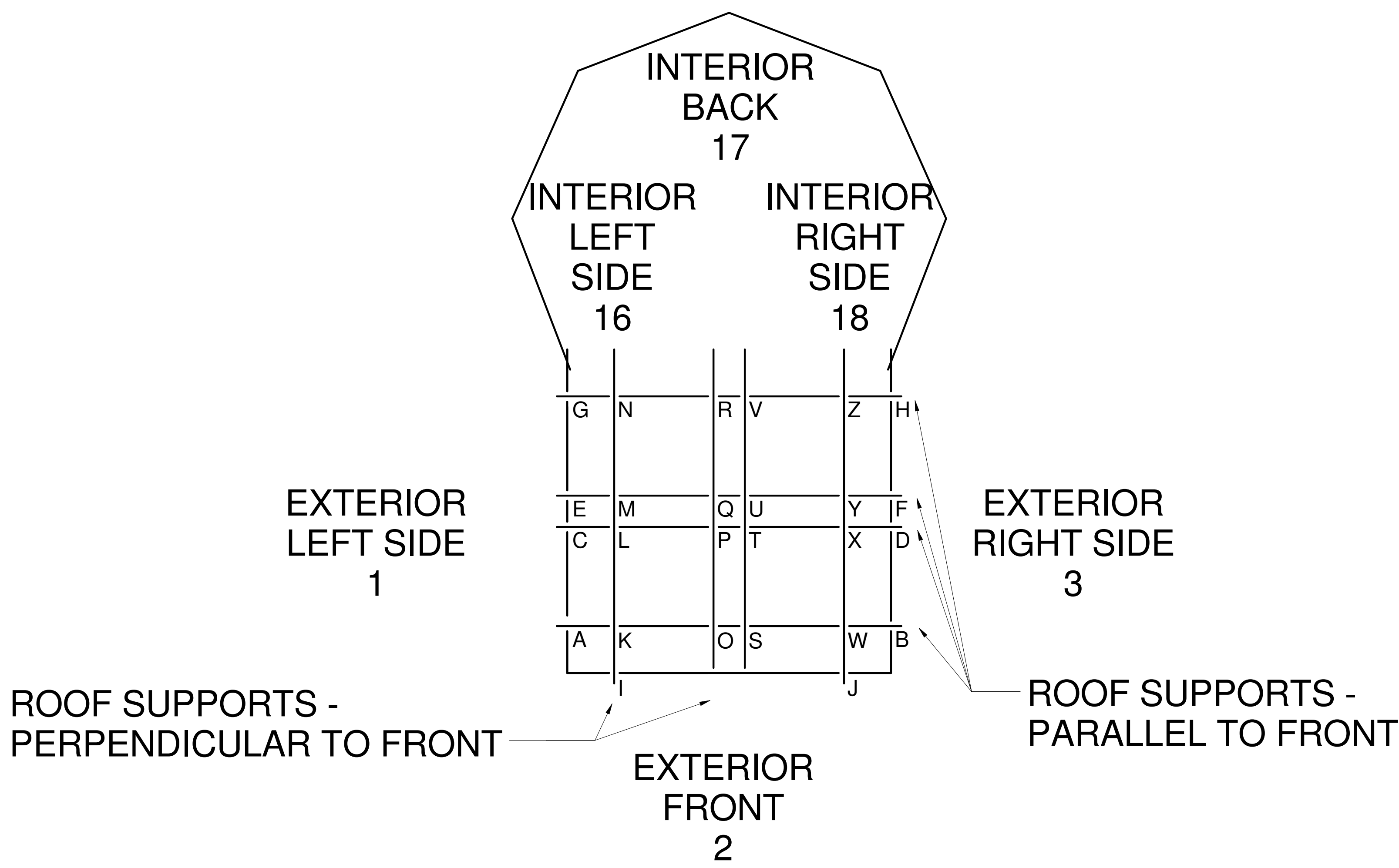
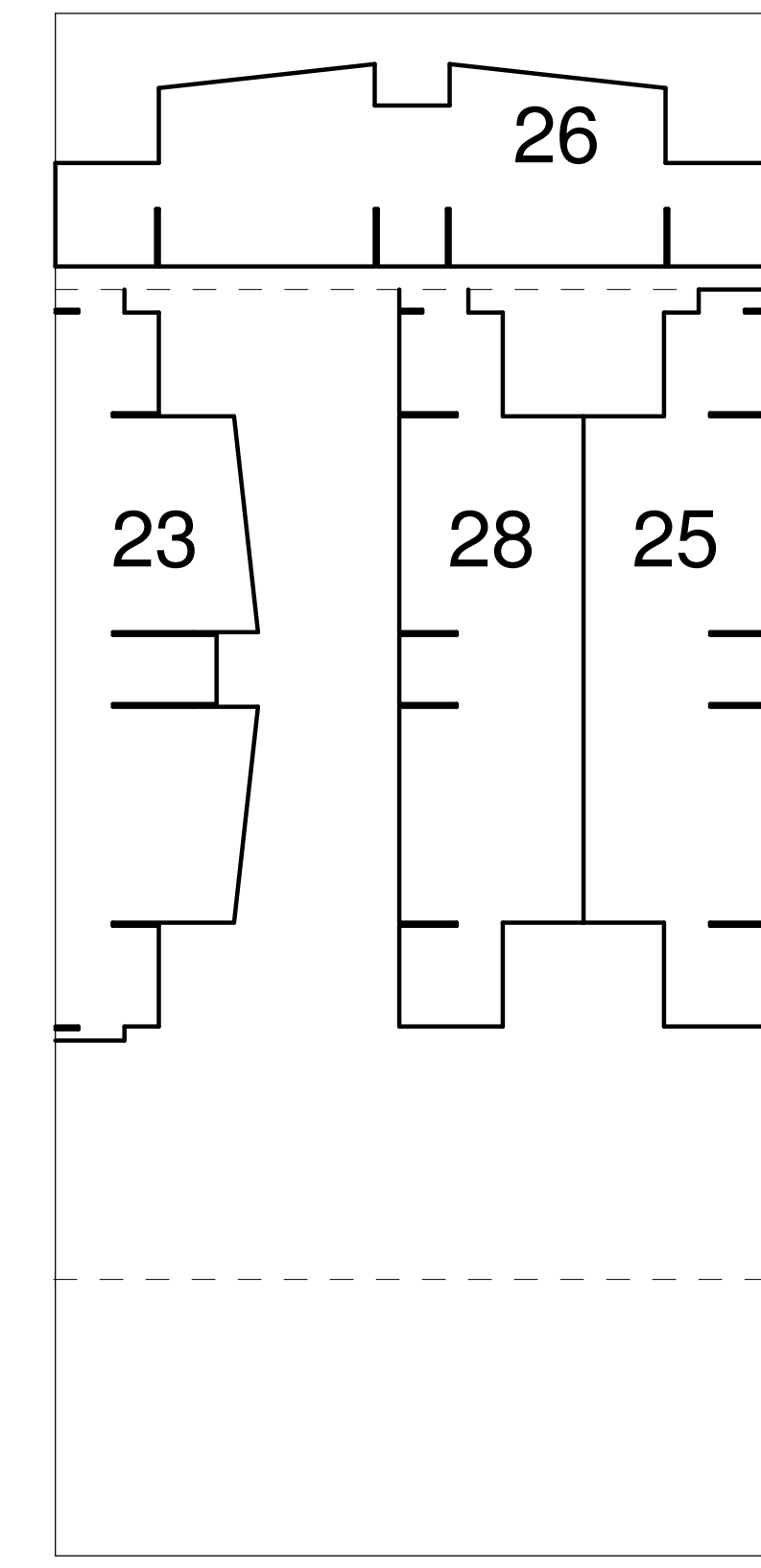
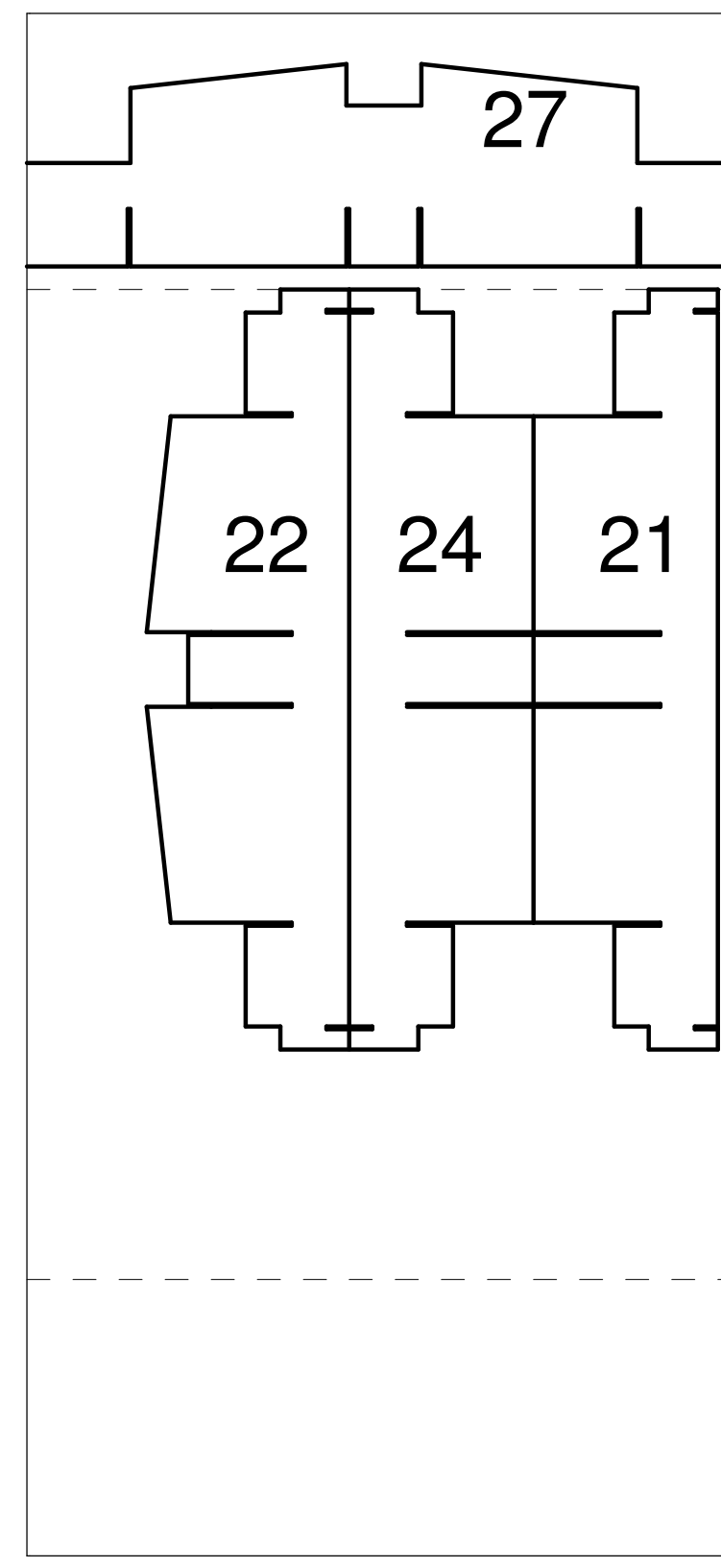
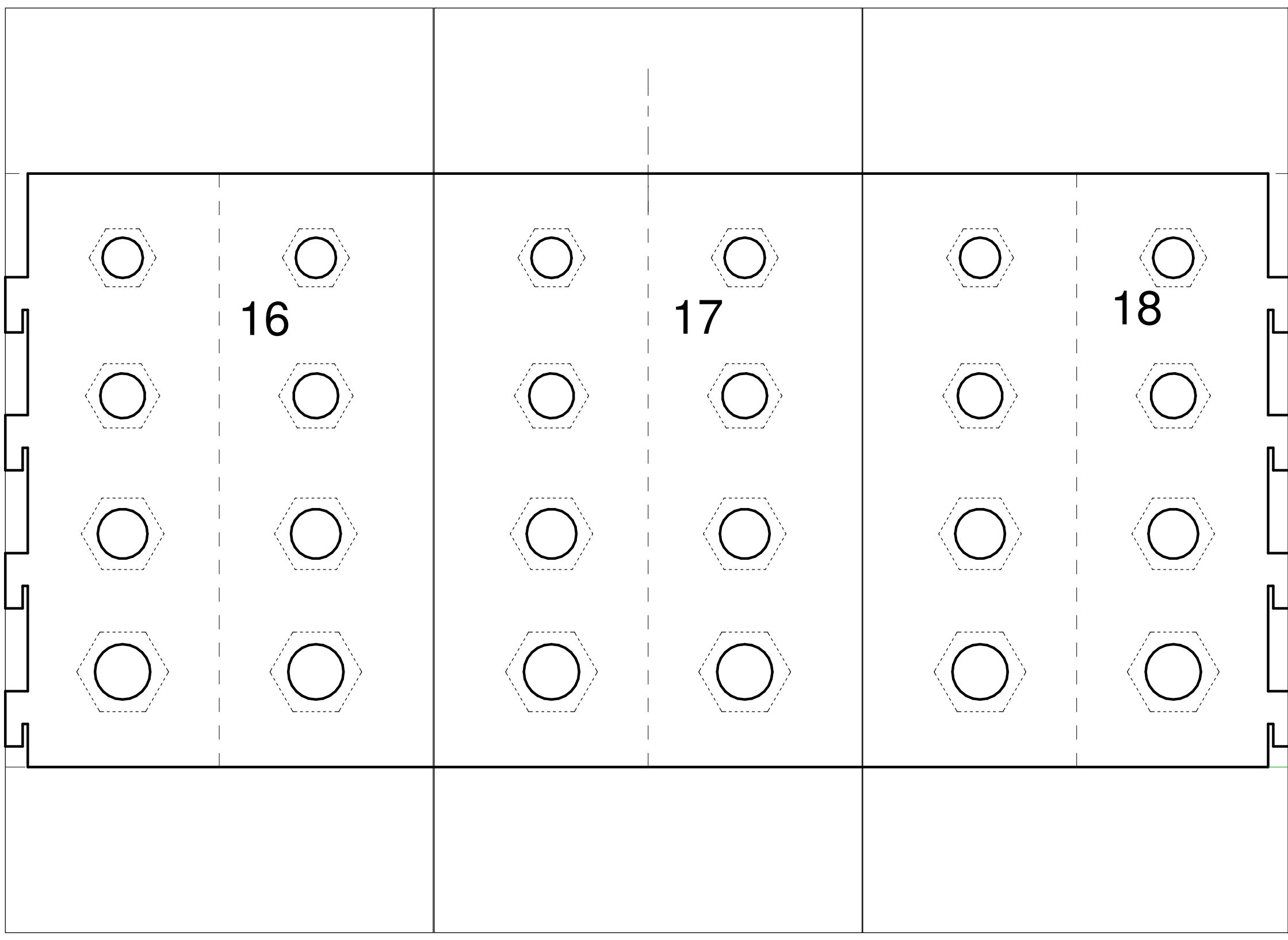
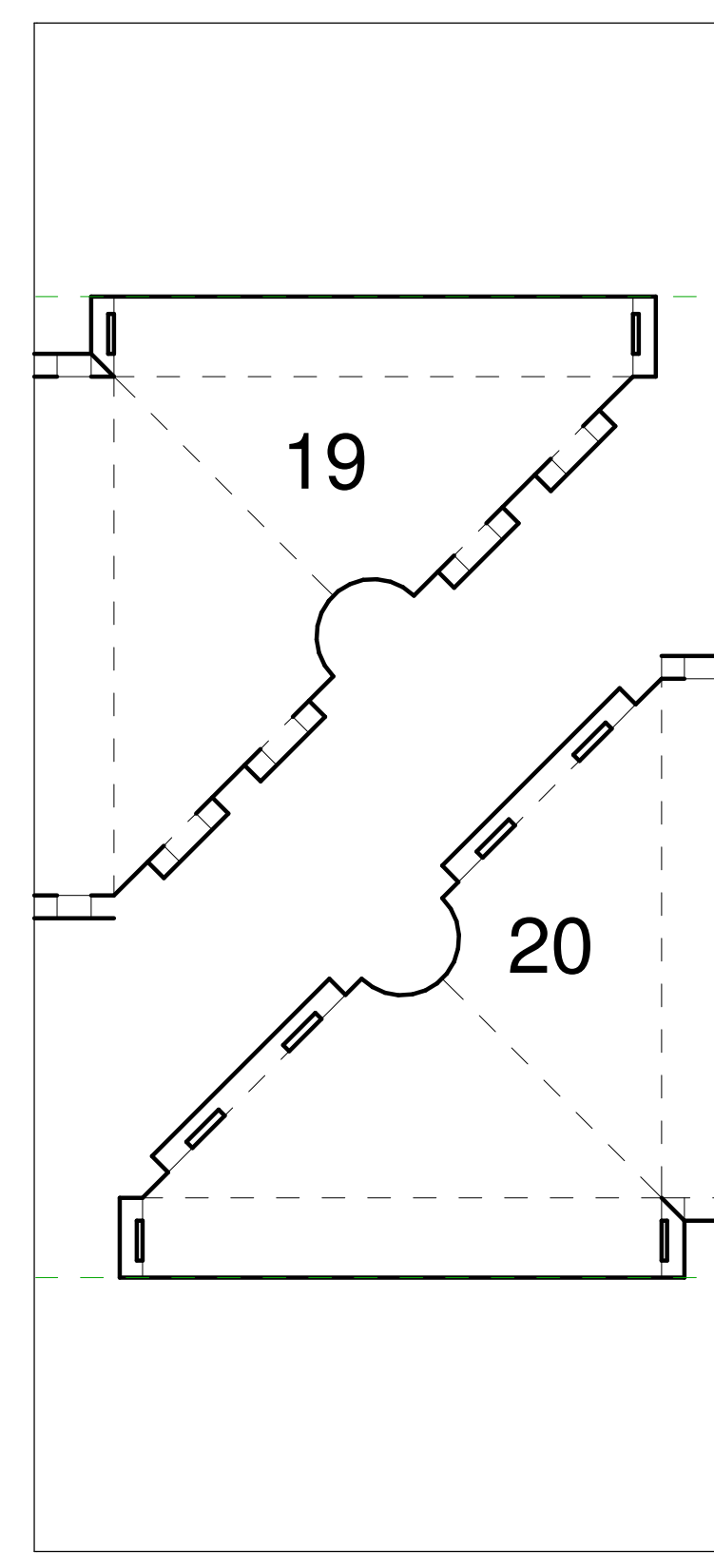
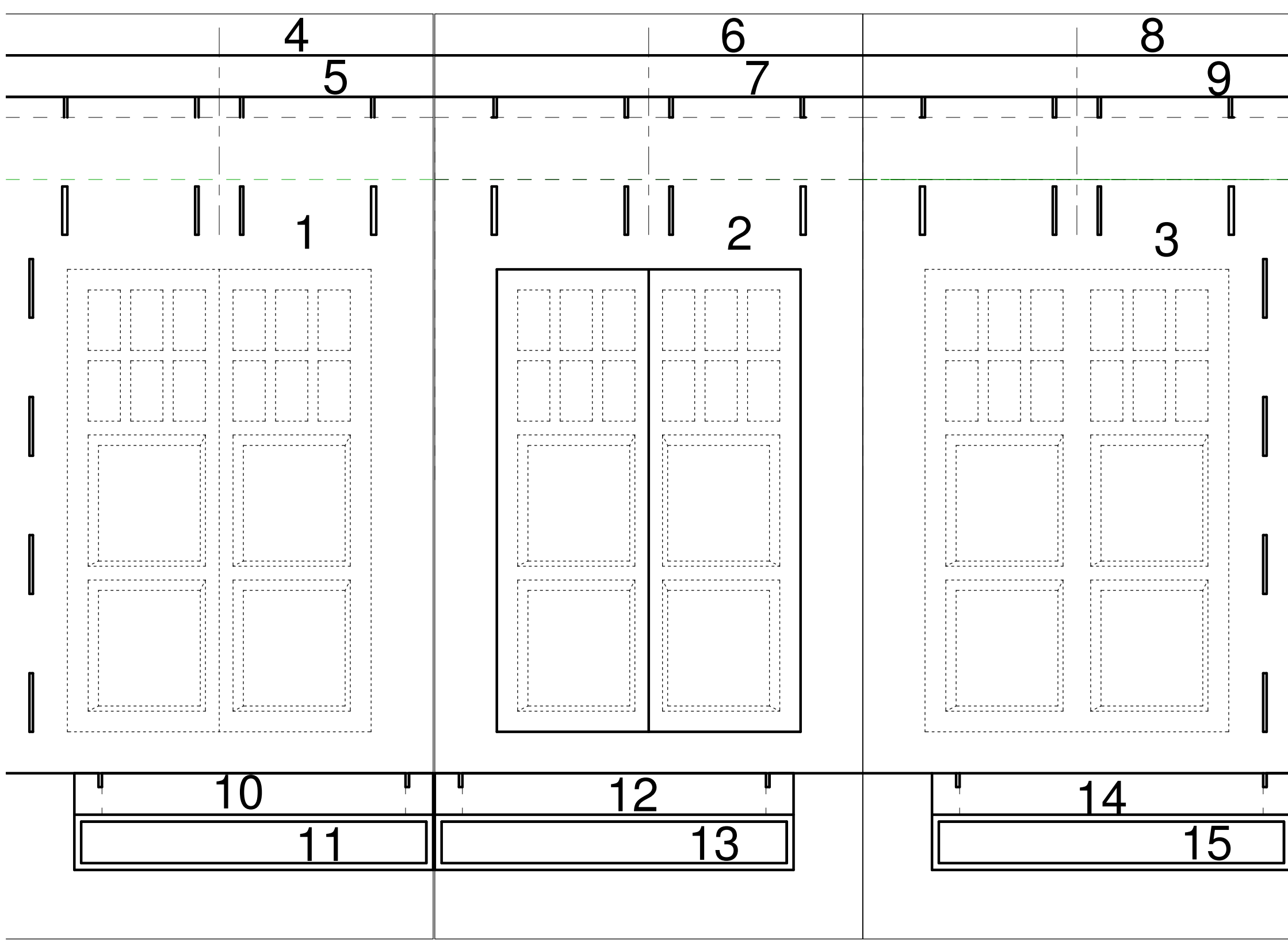

ROOF SUPPORT DIAGRAM (FOR REFERENCE)

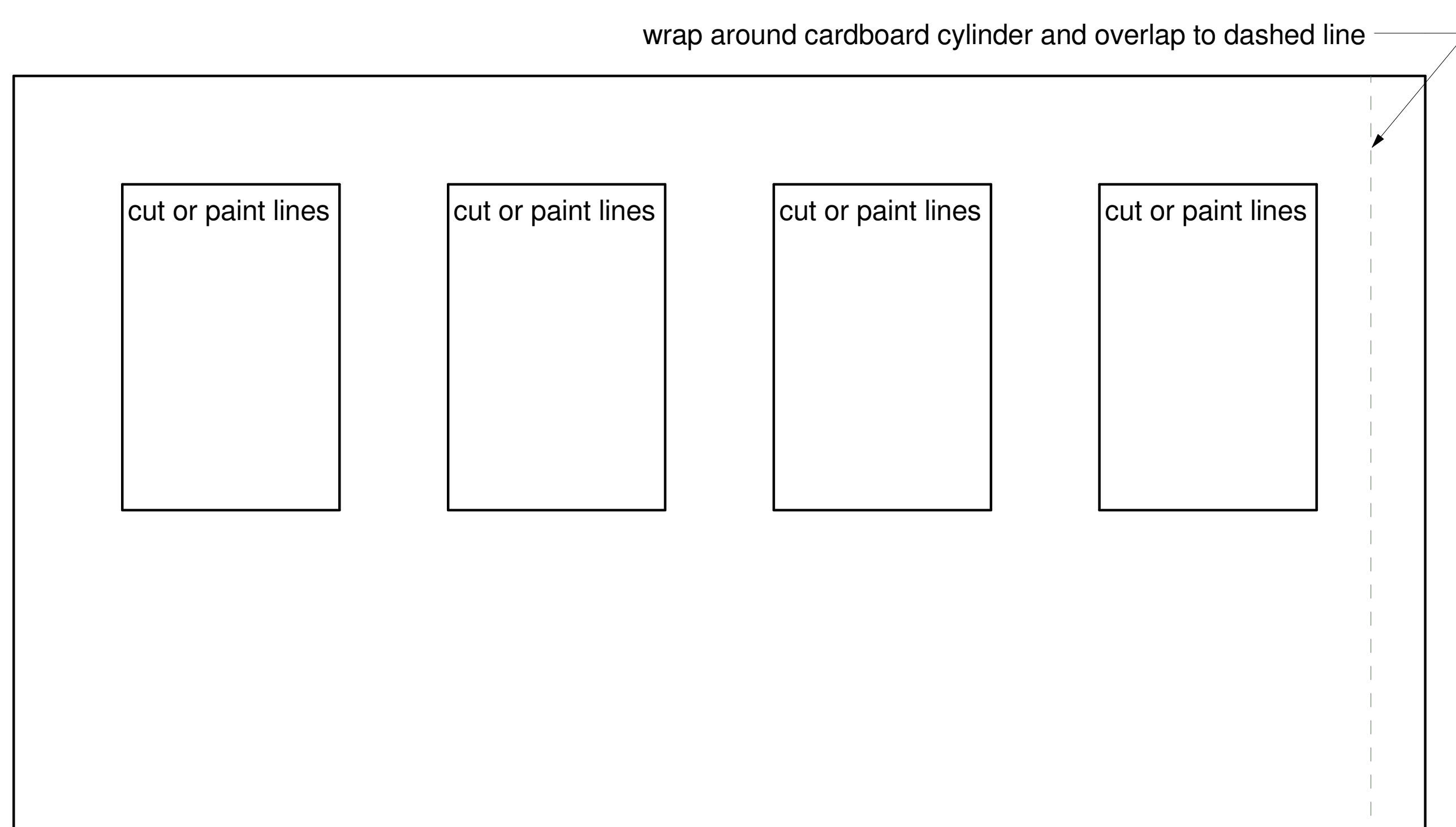

LANTERN TEMPLATE

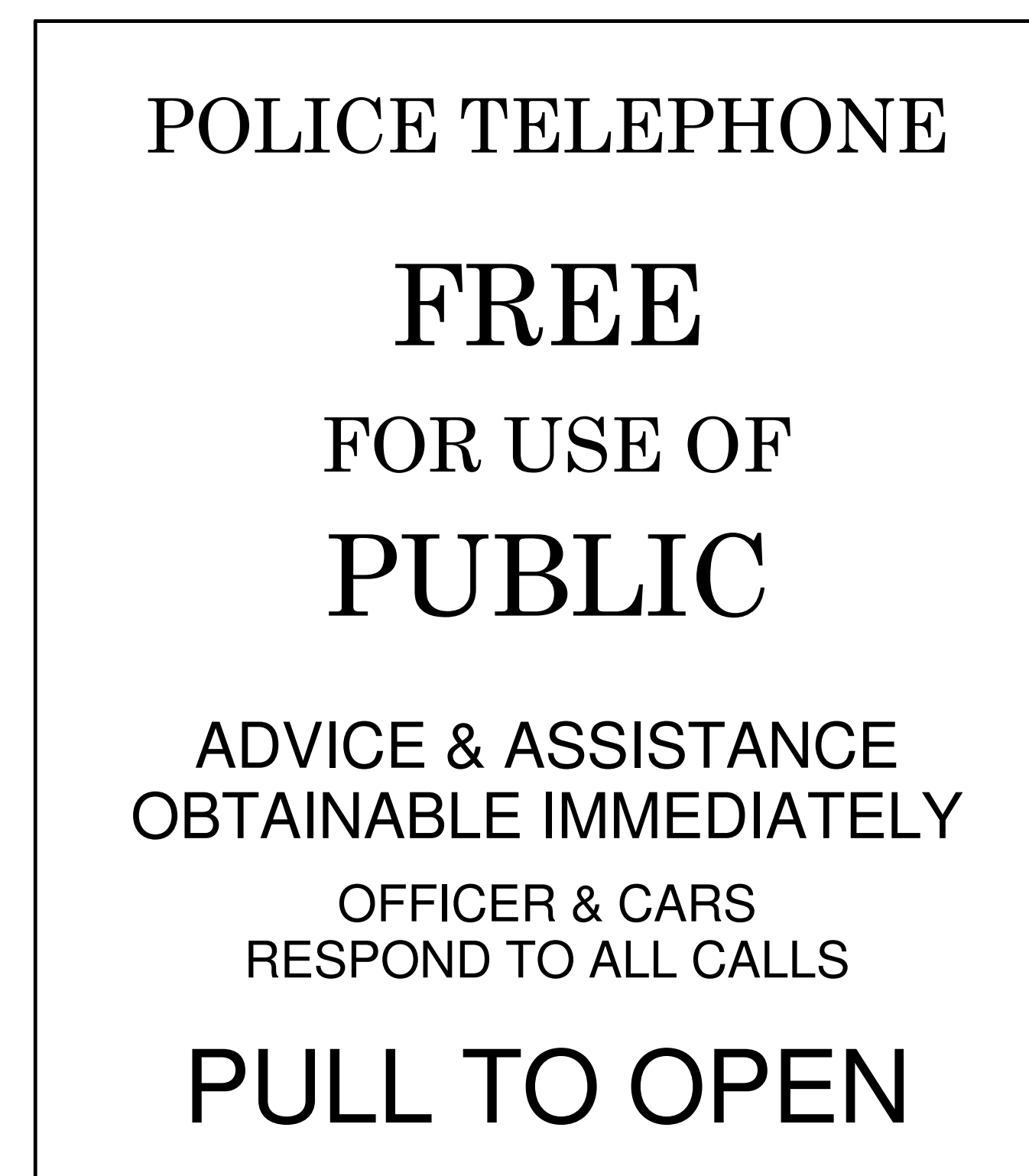

DOOR SIGN